

**EN** AUXILIARY POWER  
**FR** ALIMENTATION AUXILIAIRE  
**DE** HILFSSPANNUNG  
**IT** ALIMENTAZIONE AUSILIARE  
**ES** ALIMENTACIÓN AUXILIAR  
**PT** AUXILIAR DE ENERGIA  
**TR** YARDIMCI GÜÇ  
**PL** ZASILANIE DODATKOWE  
**NL** HULPAGGREGATEN  
**ZH** 辅助电源

① **Aux.:** 110 ... 400 VAC (50 ... 60 Hz)  
 120 ... 350 VDC  
 24 ... 48 VDC

② **Fus.:** IEC 0.5 A gG / BS88 2 A gG / 0.5 A class CC

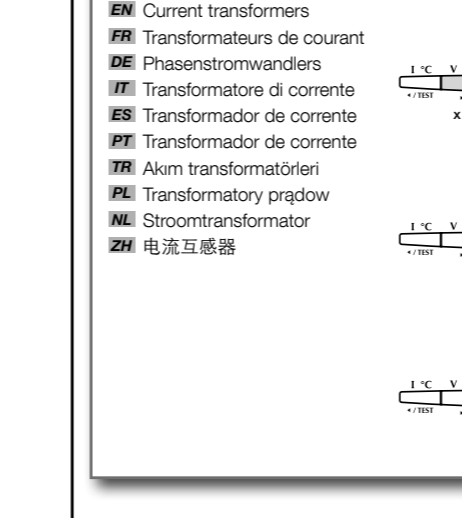
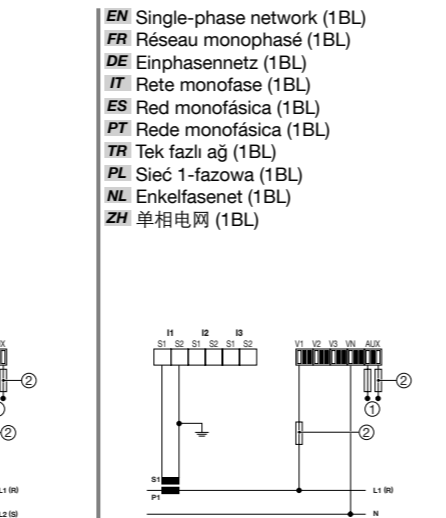
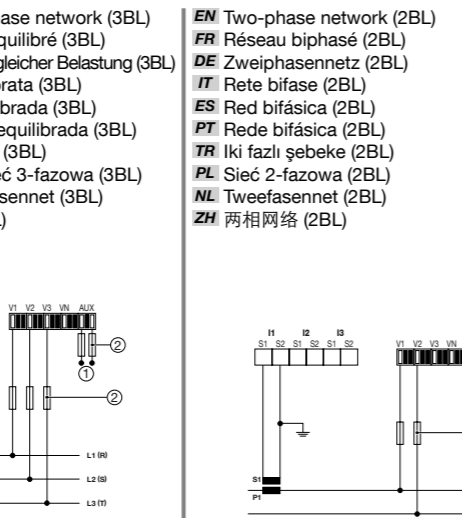
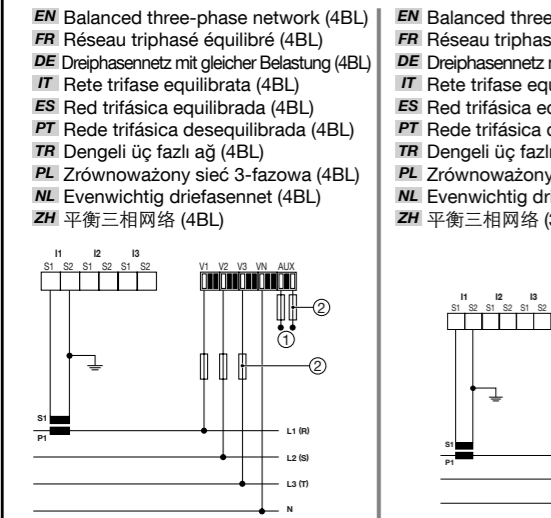
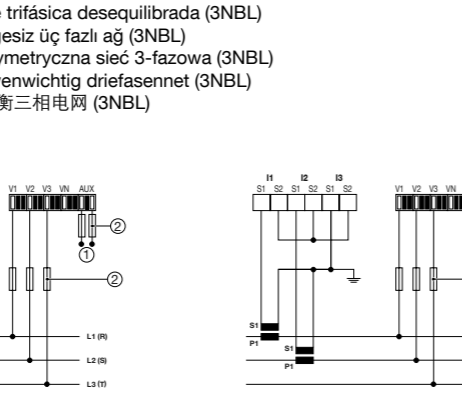
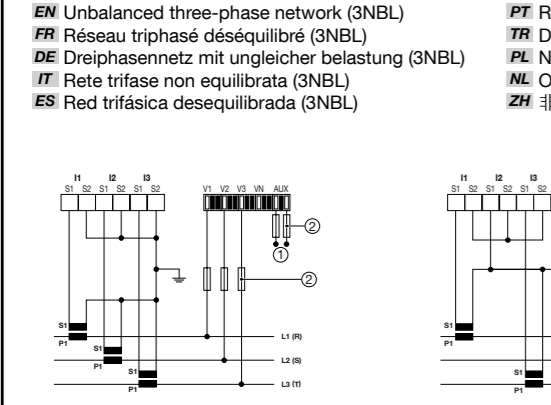
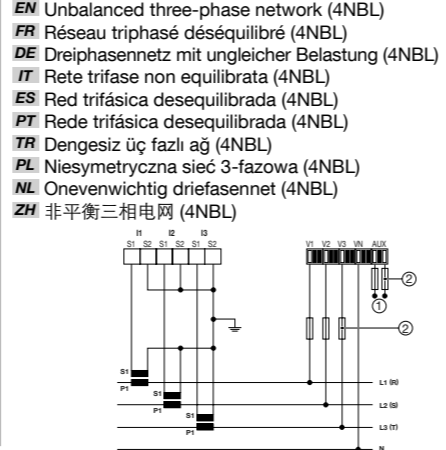

**EN** Programming example  
**FR** Exemple de programmation  
**DE** Programmierbeispiel  
**IT** Esempio di programmazione  
**ES** Ejemplo de programación  
**PT** Exemplo de programação  
**TR** Programlama örneği  
**PL** Przykład programowania  
**NL** Programmevoorbeeld  
**ZH** 编程实例

**CODe 100**

**EN** Acces to programming mode  
**FR** Entrer en programmation  
**DE** Zur Konfigurationsebene  
**IT** Accesso alla programmazione  
**ES** Entrar en modo programación  
**PT** Entrar em modo programação  
**TR** Programlama moduna erişim  
**PL** Dostęp do trybu programowania  
**NL** Overgaan tot programmeermodus  
**ZH** 进入设置模式

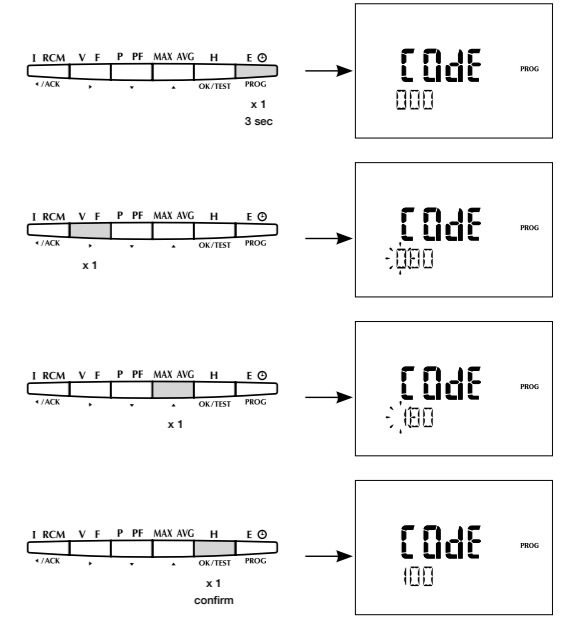

**NET = 3NBL**

**EN** Network  
**FR** Réseau  
**DE** Netzfrequenz  
**IT** Frequenza  
**ES** Frecuencia  
**PT** Frequência  
**TR** Ağ  
**PL** Sieć  
**NL** Netfrequentie  
**ZH** 电网

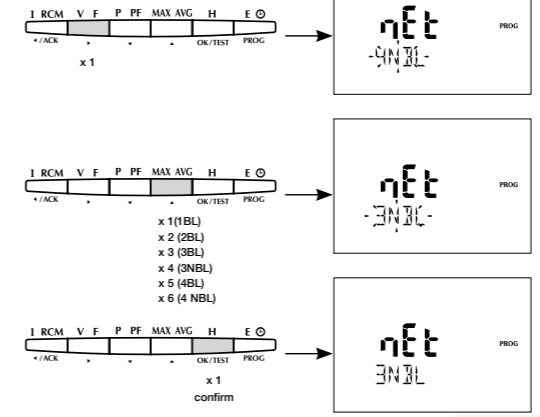

**Unom = 400V**

**EN** Nominal voltage  
**FR** Tension nominale  
**DE** Nennspannung  
**IT** Tensione nominale  
**ES** Tensión nominal  
**PT** Tensão nominal  
**TR** Anma gerilimi  
**PL** Napięcie znamionowe  
**NL** Nominale spanning  
**ZH** 额定电压

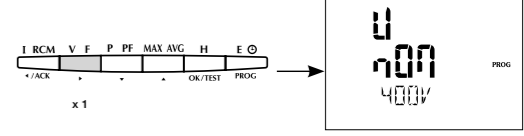

**CT = 1500/5A**

**EN** Current transformers  
**FR** Transformateurs de courant  
**DE** Phasenstromwandler  
**IT** Transformatore di corrente  
**ES** Transformador de corrente  
**PT** Transformador de corrente  
**TR** Akım transformatörleri  
**PL** Transformatory prądow  
**NL** Stroomtransformator  
**ZH** 电流互感器

