

NETYS RT

1100-1700-2200-3300 VA

Installations- und bedienungsanleitung (DE)

Installation and operating manual (EN)

Manual de instalación y uso (ES)

Asennus- ja käyttöohje (FI)

Manuel d'installation et d'utilisation (FR)

Manuale di installazione e uso (IT)

Прирачник за инсталација и употреба (MK)

Installatie- en bedieningshandleiding (NL)

Dokumentacja Techniczno-Ruchowa (PL)

Manual de instalação e funcionamento (PT)

Руководство по установке и эксплуатации (RU)

Navodila za priključitev in uporabo (SL)

Installations- och användarhandbok (SV)

安装及操作手册 (ZH)

WARRANTY CERTIFICATE AND CONDITIONS

This SOCOMEC appliance is guaranteed against manufacturing and material defects for a period of 12 months from the date of purchase (local warranty conditions are applicable in addition to the general conditions). This warranty certificate should NOT be e-mailed, but kept by the customer along with proof of purchase, for use in the event of a claim being made for repairs or replacement under warranty.

The warranty period commences on the date the new product was purchased by the end user at an authorised showroom (reference details are shown on the receipt).

Return-to-base warranty is provided: components and labour for repairs supplied free of charge, any products to be replaced must be returned to SOCOMEC or authorised service centres, at the customer's own risk and expense.

The warranty is recognized within national territory. If the UPS is exported out of national territory, the warranty shall be limited to the cover of the parts used to repair the fault.

To claim service under the warranty please observe the following:

- The product must be returned in the original packing. Any damage caused during shipping in packaging other than the original will not be covered by the warranty;
- The product must be accompanied by proof of purchase such as an invoice or receipt indicating the date of purchase and product ID information (model, serial number). The sender must also attach the reference number issued to authorise the return of the product, together with a detailed description of the defect. If any of this information is missing the warranty will be invalid. The authorisation number is issued by service centres over the telephone on receiving information on the malfunction in question;
- If it is not possible to provide proof of purchase the serial number and date of manufacture will be used to calculate the probable expiry date of the warranty; this could result in a reduction of the original warranty period.

The warranty on the product does not cover damage caused by carelessness (improper use: wrong input power, explosions, excessive humidity, temperature, poor ventilation, etc.), tampering or any unauthorised repair work.

During the warranty period, SOCOMEC reserves the right to decide whether the product should be repaired, or whether to replace defective parts with new parts, or used parts that are equivalent to new parts in terms of functionality and performance.

In the case of batteries, warranty is valid only if the battery has been recharged regularly in accordance with the manufacturer's instructions. On purchasing the product it is advisable to check that the next recharge date indicated on the packaging has not expired.

Battery

- Batteries are treated as consumable parts and warranty only covers manufacturing defects.
- Batteries must be stored in compliance with Supplier recommendations.
- Warranty is valid only if the battery has been recharged regularly in accordance with the manufacturer's instructions. On purchasing the product it is advisable to check that the next recharge date indicated on the packaging has not expired.

Optionals

A 12-month return-to-base warranty is provided on optionals.

Software products

Software products are guaranteed for 90 days. The software is guaranteed to work as indicated in the manual accompanying the product. Hardware media or accessories (e.g. diskettes, cables, etc.) used with appliances are guaranteed free of material or manufacturing defects under normal conditions of use for a period of 12 months from the date of purchase.

SOCOMECEC will not be responsible for damages (including loss of income, interruption of business activity, loss of information or other financial losses, of any nature) arising from the use of the product.

These conditions are subject to Italian law. Disputes shall come under the jurisdiction of Court of Vicenza.

SOCOMECEC retains the full and exclusive ownership rights over this document. Only a personal right to utilize the document for the application indicated by SOCOMEC is granted to the recipient of such document. All reproduction, modification, dissemination of this document whether in part or whole and by any manner are expressly prohibited except upon Socomec's express prior written consent.

This document is not a specification. SOCOMEC reserves the right to make any changes to data without prior notice.

TABLE OF CONTENTS

1. SAFETY STANDARDS	4
1.1 IMPORTANT	4
1.2 DESCRIPTION OF THE SYMBOLS USED ON THE LABELS APPLIED TO THE UNIT.	5
2. INSTALLATION	6
2.1 ENVIRONMENTAL	6
2.1 ELECTRICAL	7
2.2 VERTICAL INSTALLATION	7
2.3 HORIZONTAL INSTALLATION ON RACK	9
3. REAR VIEW	12
4. CONNECTIONS	13
5. CONNECTION OF BATTERY EXTENSION	14
5.1 SAFETY WARNINGS	14
5.2 CONNECTION OF BATTERY EXTENSION	14
6. MIMIC PANEL	16
7. OPERATING MODES	17
7.1 BATTERY RECHARGE	17
7.2 SWITCHING THE NETYS RT ON AND OFF	17
7.3 BATTERY TEST	18
8. VISUAL AND AUDIBLE WARNING SIGNALS	19
9. SETTINGS	20
9.1 SETTING MENU	20
9.2 SETTINGS	20
10. COMMUNICATION	22
10.1 COMMUNICATION SOLUTIONS	22
10.2 USB INTERFACE	22
10.3 RS232 INTERFACE	22
10.4 EPO PORT	22
10.5 WEB/SNMP CARD (OPTION)	22
10.6 USE OF WARNING RELAY INTERFACE	22
11. MAINTENANCE	25
11.1 MINOR TROUBLESHOOTING	25
12. TECHNICAL SPECIFICATIONS	26

1. SAFETY STANDARDS

1.1 IMPORTANT

This manual should be kept in a safe place near the UPS, so it can be consulted by the operator at any time for information that may be needed regarding correct use of the unit. Read the manual carefully before connecting the unit to the a.c. mains supply and the downstream appliances. Before the UPS is put into commission the user should be completely familiar with its operation, the position of all the controls and the technical and functional characteristics of the unit, so as to ensure there will be no risk to people or the appliance itself.



WARNING!

This is a product for commercial and industrial applications in an industrial environment – installation restrictions or additional measures may be needed to prevent electro-magnetic interferences.

- The product you have chosen is designed for commercial and industrial use only. In order to be used for particular “critical applications” such as life support systems, medical applications, commercial transportation, nuclear facilities or any other application or systems where product failure is likely to cause substantial harms to person or property, the products might require compliance with statutory regulations and standards, specific local by-laws and be adapted accordingly. For such uses we would advise you to contact SOCOMEC UPS beforehand to confirm the ability of these products to meet the requested level of safety, performance, reliability and compliance with applicable laws, regulations and specifications.

- Use the UPS in accordance with the technical specifications indicated in this manual.
- To meet Emergency Switch Device (ESD) operating requirements, a specific input with remote ESD/EPO function is available.



DANGER!

To avoid dangerous electric-shock, the UPS must be powered using a socket with protective earth connection. It is mandatory the use of the provided cable (ref. - CONNECTIONS).

- This earth connection will assure also the safety bonding for the appliances powered by the UPS. The manufacturer declines all liability for any damage or accidents that could result from failure to observe the requirements.
- Should a power outage occur, do not disconnect the power cord from the mains, since this will cut the earth connection, both for the UPS and the appliances.
- The UPS generates a leakage current of approximately 3 mA. Ensure the leakage current generated by the load is no greater than 0.5 mA in order to be compliant with the safety standard. Should the leakage current from the load exceed this limit, directly connect the UPS PE connection to the ground system.
- If a hazardous situation should arise at any time when the UPS is in use, isolate the unit from the power supply (by operating a switch at the upstream PDU if possible) and switch the appliance off completely by running the shutdown procedure.
- The UPS houses a source of electrical energy, i.e. its batteries. The output of the UPS may be powered even when the appliance is not connected to the a.c. mains supply.
- All maintenance operations must only be performed by authorised service engineers. The UPS generates high internal voltages that could be hazardous for a maintenance operative not in possession of the appropriate skills and training for this type of work.
- Never force, break or attempt to open the batteries. These batteries are sealed, maintenance-free components containing substances that are harmful to health and a source of environmental pollution. If liquid can be seen leaking from the battery, or a white powdery residue is noticeable, do not switch the UPS on.
- Avoid exposing the UPS to contact with water or any liquids generally. Do not insert foreign objects into the cabinet.
- Danger of explosion if the batteries are replaced with others of the wrong type.
- Replaced batteries must be disposed of at authorised waste disposal centres.



It is very dangerous to touch any part of the batteries as there is no insulation between the batteries and the mains power source.



CAUTION!
A battery can present a risk of electrical shock and high short circuit current.

- If the appliance is to be disposed off it should only be entrusted to a specialist waste disposal company. These companies will dismantle and dispose of the various components in accordance with statutory regulations in the country of purchase.



**CAUTION IF DAMAGED
NON-SPILLABLE BATTERIES**

Torn, crushed or damaged packaging which exposes the contents should be set aside in an isolated area and inspected by a qualified person. If the package cannot be shipped the contents must be promptly collected, segregated, and either the sender or recipient contacted.

All packaging material must be recycled in compliance with the laws in force in the country where the system is installed.

1.2 DESCRIPTION OF THE SYMBOLS

Comply with all precautions and warnings on labels and plates on the inside and outside of the equipment.



DANGER! HIGH VOLTAGE (BLACK/YELLOW)



GROUND TERMINAL



READ THE USER MANUAL BEFORE USING THE UNIT

2. REQUIREMENTS FOR INSTALLATION

Consult the following check list when installing the UPS:

2.1 ENVIRONMENTAL

- NETYS RT units are designed for use in enclosed environments.
- Position the UPS on a flat and stable surface in a properly ventilated room, well away from heat sources and avoiding direct exposure to sunlight.
- Check that the UPS will not be installed in a dust-laden environment.
- Do not install the UPS system near water or in damp environments.
- Condensation may occur if the UPS system is moved directly from a cold to a warm environment. The UPS system must be completely dry before being installed. Please allow at least two hours for the UPS system to become acclimatised to the environment.
- Ambient temperature should be maintained between 0 °C and 40 °C, and relative humidity below 90% (without condensation); the optimum temperature in terms of maximizing battery life is 15-20 °C.
- Be certain that a clearance of at least 15 cm is left on front and back sides of the unit to ensure adequate ventilation and provide access to the rear panel.
- Take care not to stand the UPS or any other heavy object on cables.

2.2 ELECTRICAL

- Check that the operating voltage and frequency settings are correct for the mains power supply at the installation site. Details for the UPS will be found on the data plate affixed to the rear panel.
- The mains supply socket must be protected by a 30 mA type A residual current circuit breaker.
- The UPS when connected to the mains socket, do not modify the neutral system
- Ensure there is a reliable earth connection.
- Connect the UPS system to an earthed shockproof outlet only, which is easily accessible and close to the UPS system.
- Ensure external battery sources are earthed.
- When making the RS232 serial connection, use only the cables and accessories supplied.
- Do not connect appliances or devices which would overload the UPS system (e.g. laser printers) to the UPS output sockets.
- When the UPS is first used, it is advisable to leave the battery on charge for a minimum of 8 hours.



PRECAUTIONS IN THE EVENT OF DAMAGE

DO NOT OVERTURN THE BATTERIES.

Packing materials that have been broken, punctured or torn in such a way as to reveal the contents must be kept separate in a secure area, and inspected by skilled staff. Any packing considered unsuitable for shipment of the contents must be set aside immediately and kept secure, and the sender or recipient contacted.

Electrical requirements		
UPS	Circuit breaker to be installed upstream of the UPS	Input leakage current
1.1 kVA	8 C 2P	< 3.5 mA
1.7 kVA	13 C 2P	< 3.5 mA
2.2 kVA	16 C 2P	< 3.5 mA
3.3 kVA	16 C 2P	< 3.5 mA

2.3 VERTICAL INSTALLATION

Correct Installation

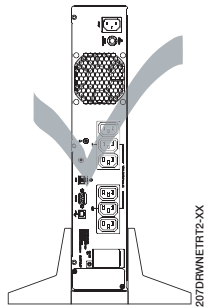

Wrong installation

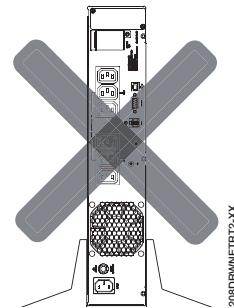

UPS Installation

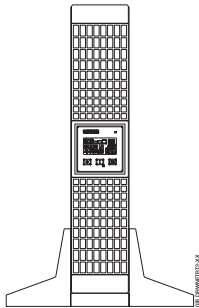

UPS Installation with 1 battery extension

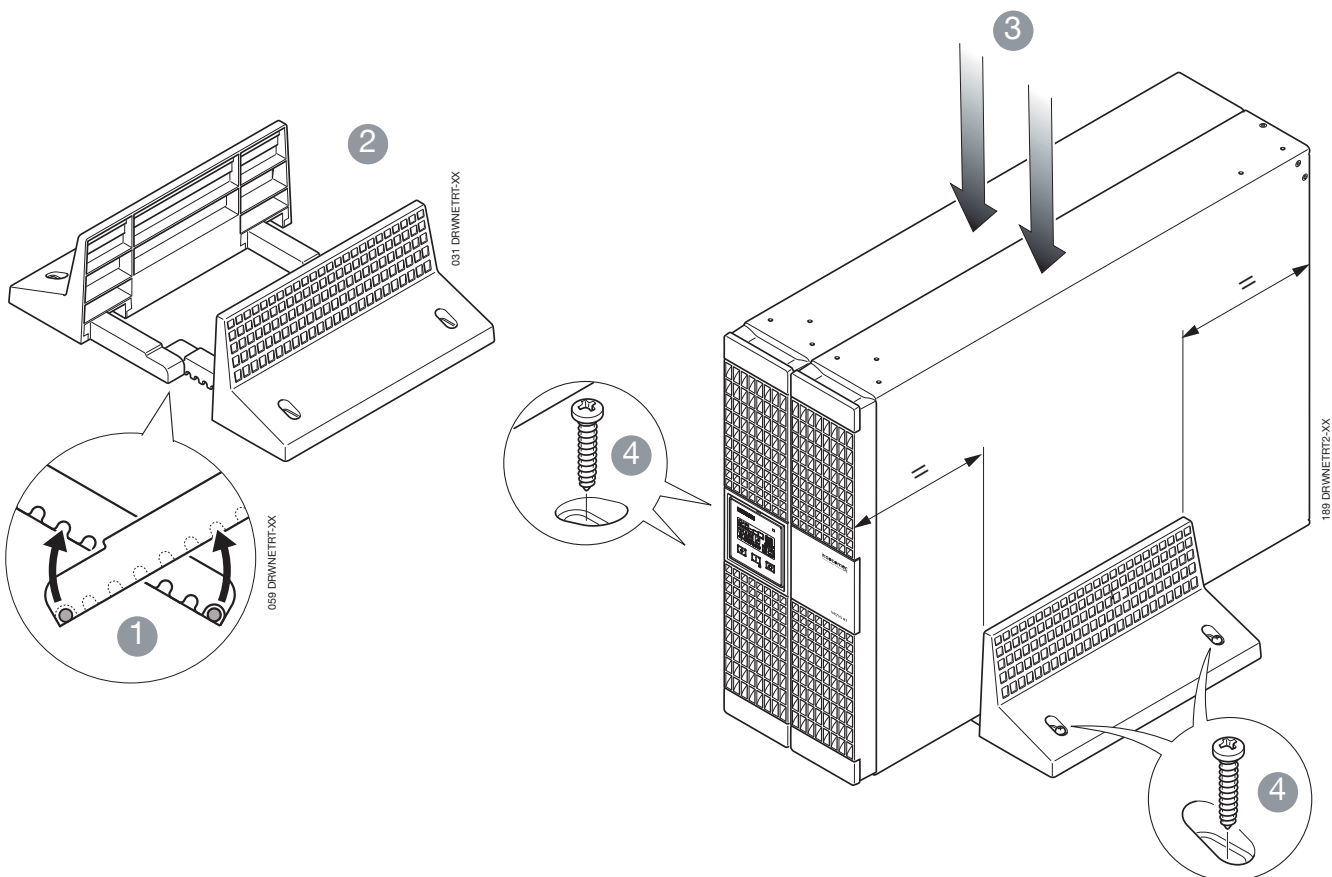
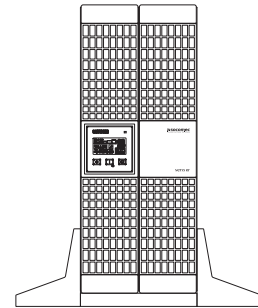

2.3.1 UPS Installation with multiple battery extensions

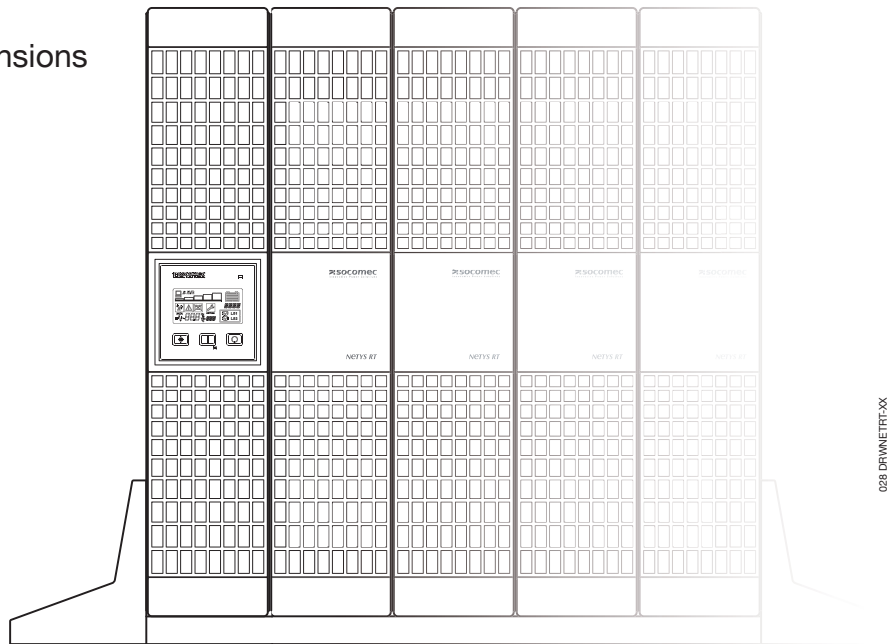

028 DRAWNET-XX

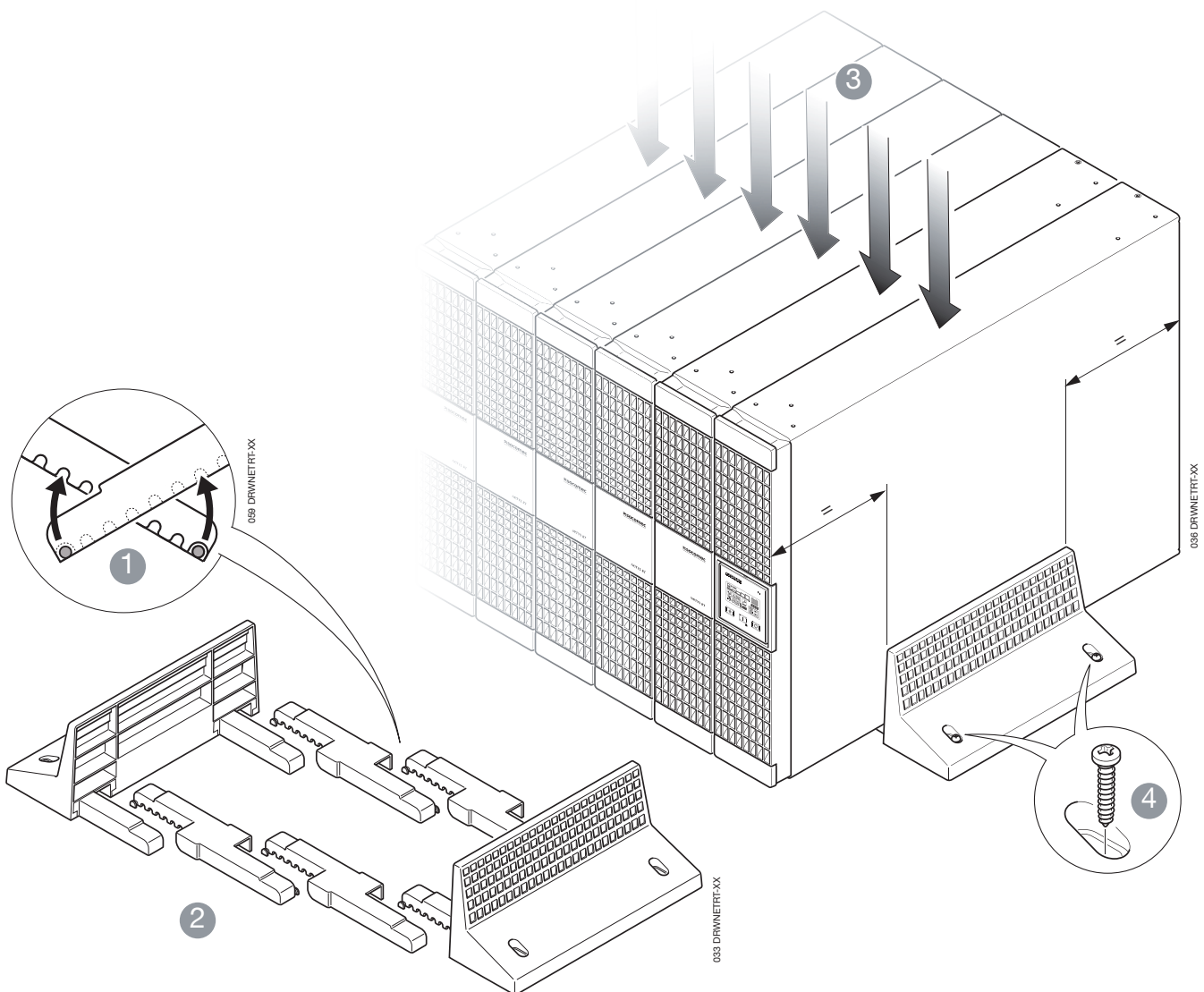

036 DRAWNET-XX

2.4 HORIZONTAL INSTALLATION ON RACK

2.4.1 Rotation of mimic pannel

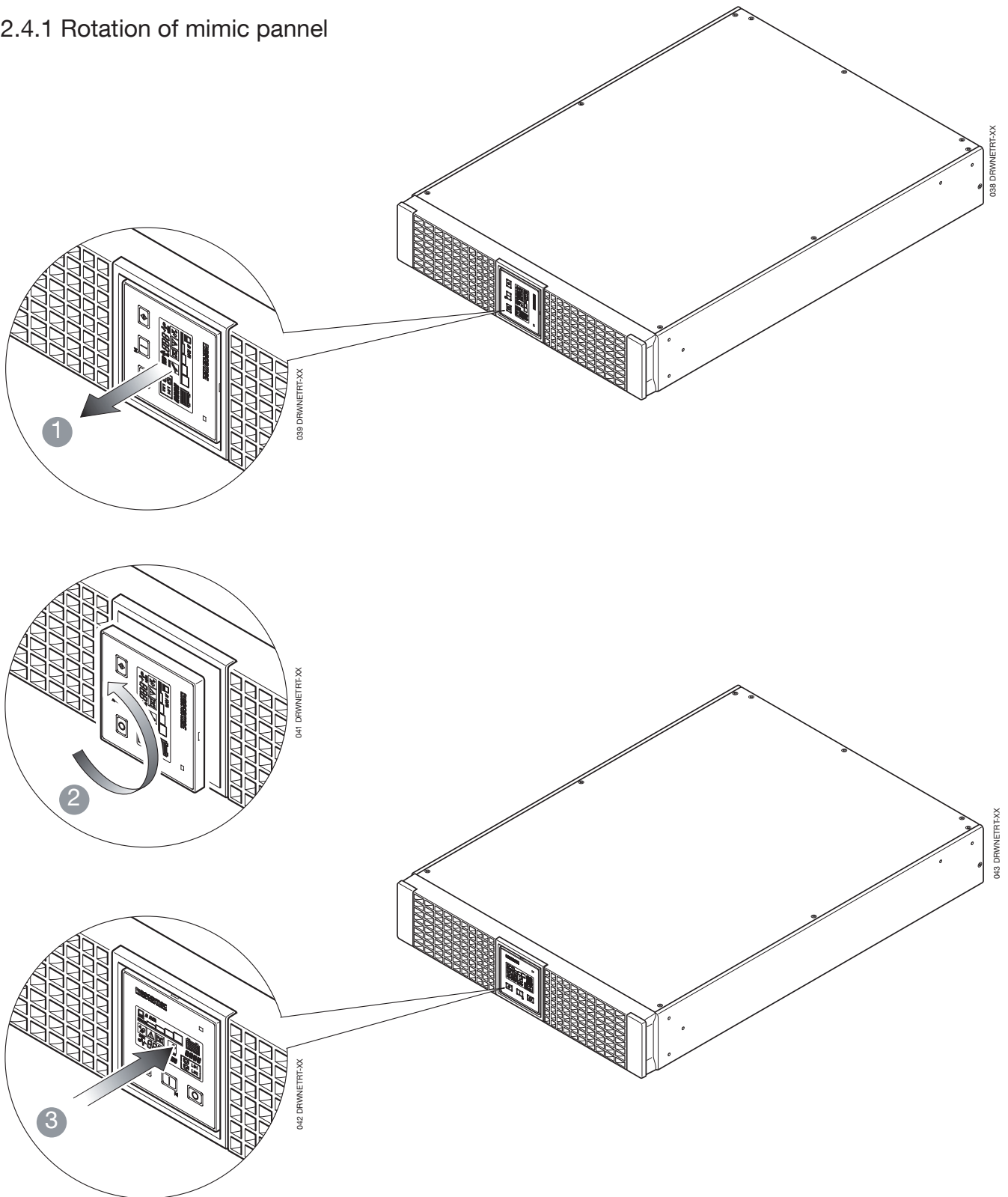

2.4.2 Fitting rack brackets

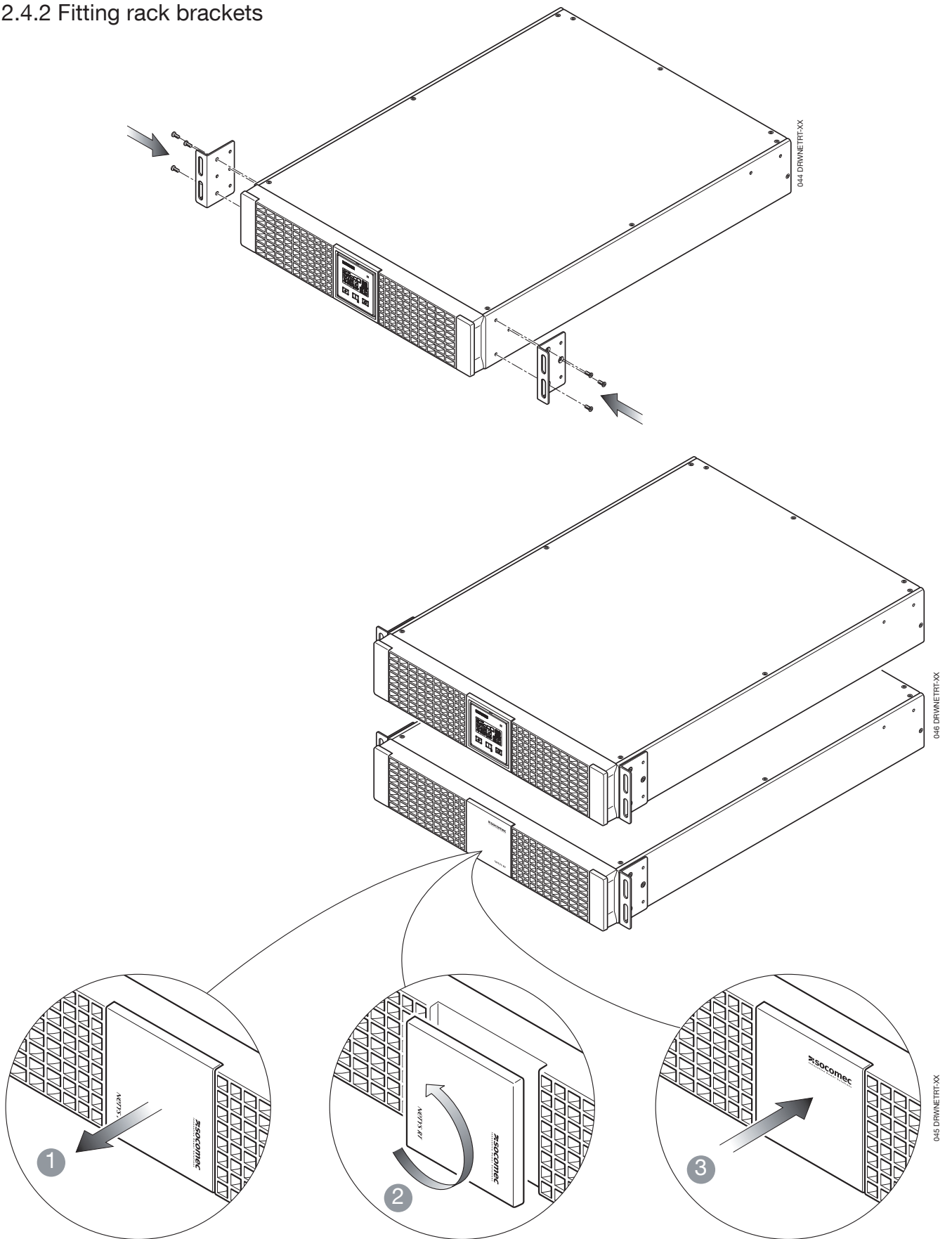

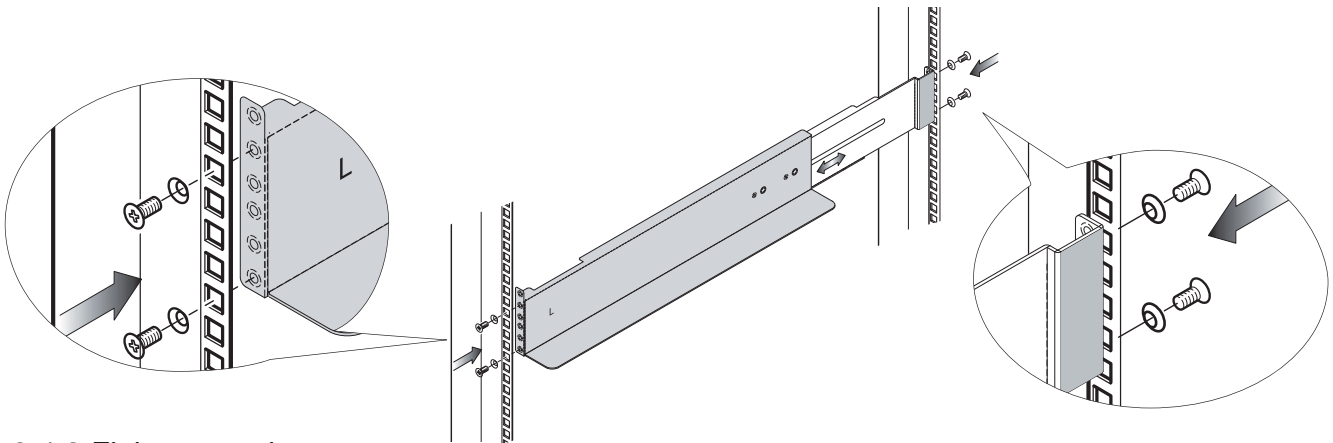

2.4.3 Fixing to rack

1. Adapt the length of the tracks to fit the rack.
2. Secure the wing nuts.
3. Fix the track to the rack.
4. Slot in the UPS and tighten the screws.

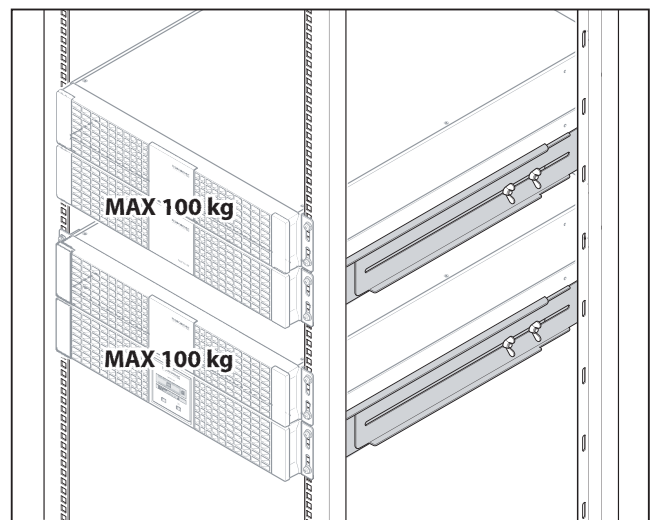
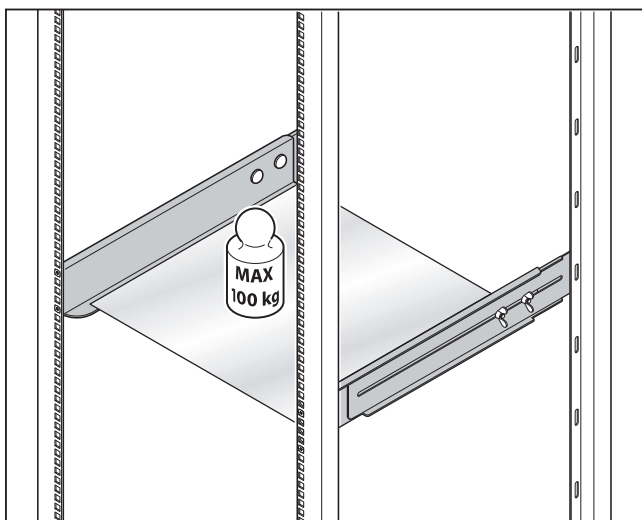
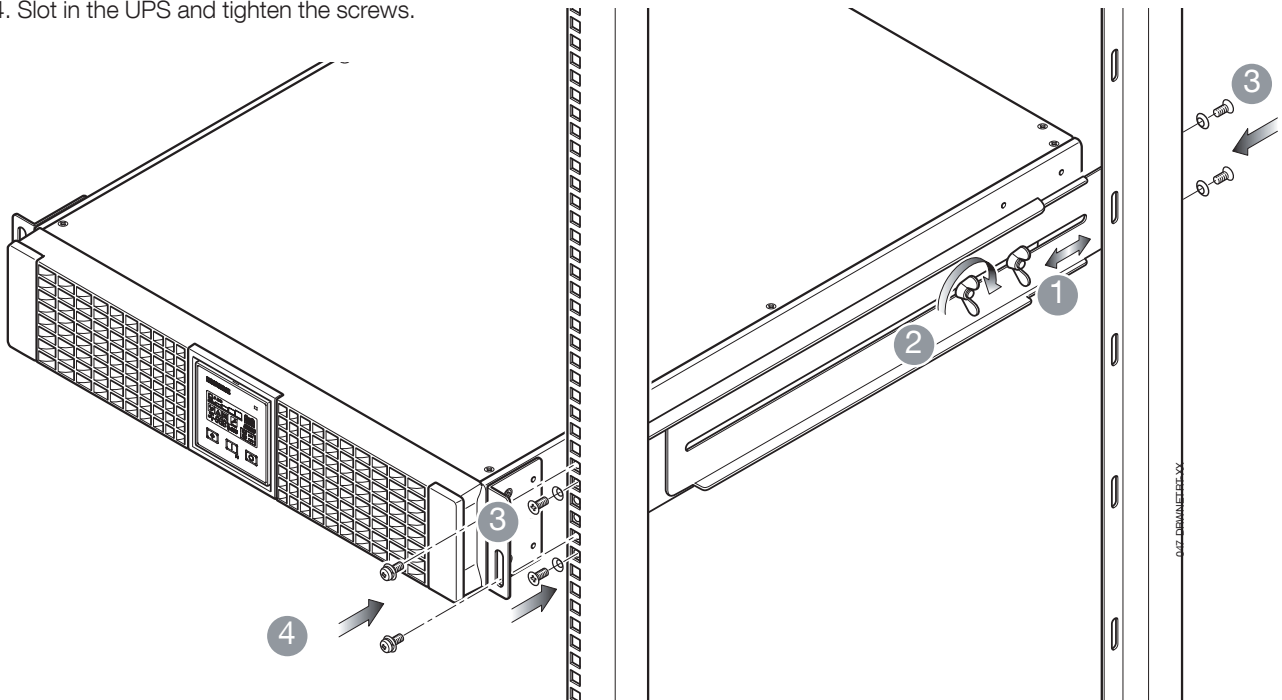

3. REAR VIEW

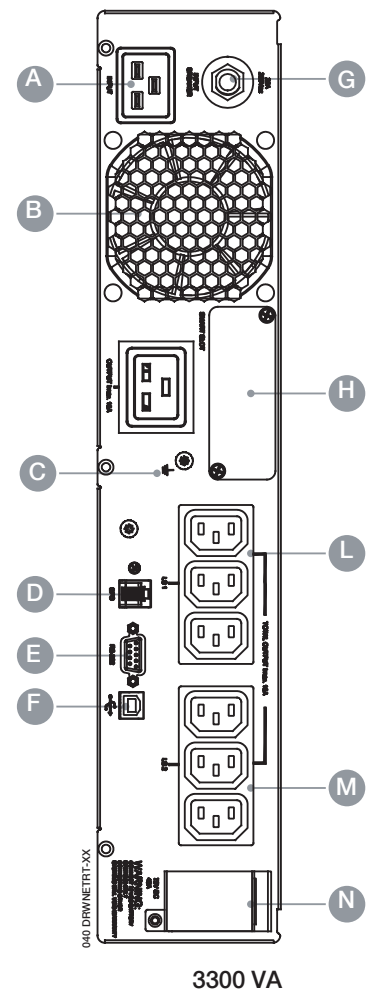
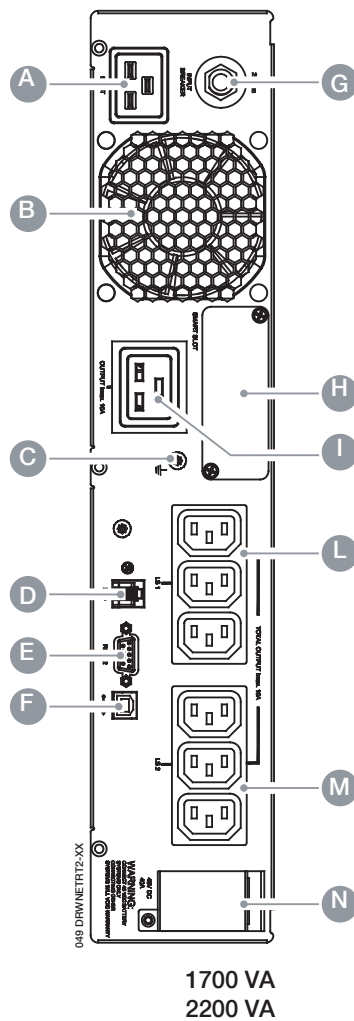
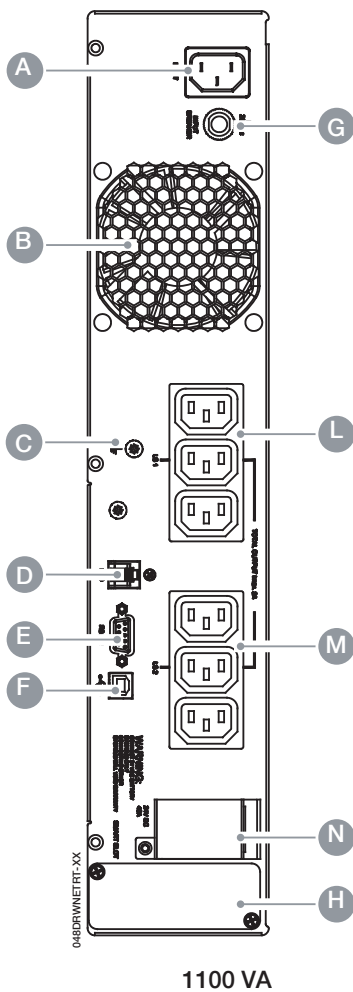

Legend

- A Mains input socket (IEC 320)
- B Fan
- C UPS PE Output socket (full power)
- D EPO (Emergency Power Off)
- E RS232 serial connector (JBUS protocol)
- F USB socket
- G Input thermal protection
- H Slot for optional communication cards
- I Output socket (full power)
- L Power output sockets (LS1 programmable via SNMP)
- M Power output sockets (LS2 programmable via SNMP)
- N Battery extension socket

4. CONNECTIONS

Connection to the mains power supply and to the load(s) must be made using cables of suitable cross section, in accordance with current standards.

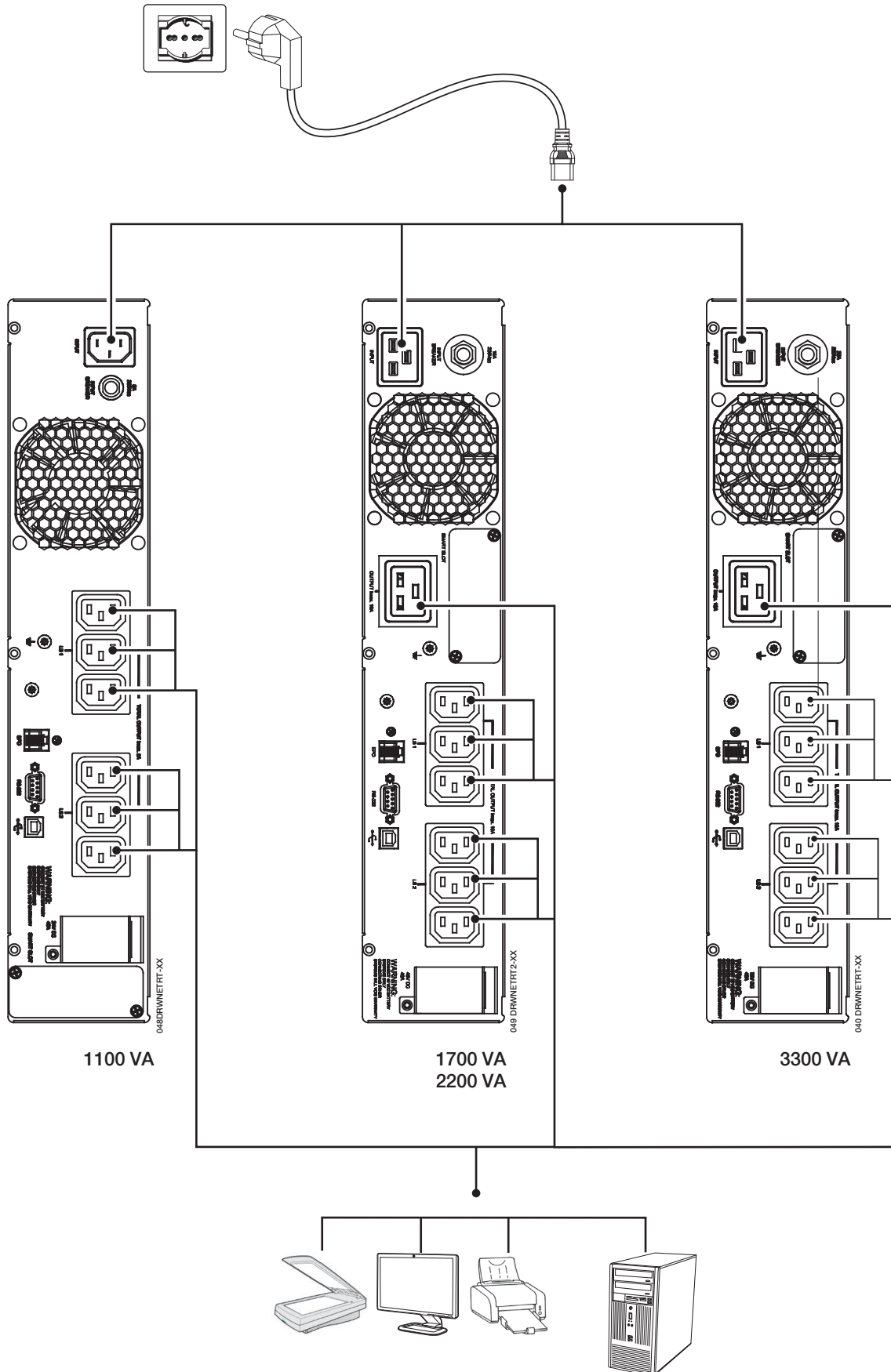

5. CONNECTION OF BATTERY EXTENSION

5.1 SAFETY WARNINGS

- Before connecting the battery extension, check that it is fully compatible with the model of UPS in use.
- The use of battery extensions not supplied by the manufacturer is inadvisable.



WARNING!

There is a risk of explosion if battery modules are replaced with others of incorrect type.

- Depleted batteries are considered as toxic waste. When battery replacement becomes necessary, release all depleted batteries only to certified and licensed waste disposal companies. In accordance with local bylaws, it is absolutely forbidden to dispose of batteries together with other industrial waste or household refuse.



WARNING!

It is extremely dangerous to touch any part of the battery storage unit.

5.2 CONNECTION OF BATTERY EXTENSION



WARNING!

Before commencing any operation, make certain that:

- the voltages of the UPS battery and of the battery extension are the same,
 - 1.1 kVA 24 VDC (NRT2-B1100)
 - 1.7 kVA 48 VDC (NRT2-B2200)
 - 2.2 kVA 48 VDC (NRT2-B2200)
 - 3.3 kVA 72 VDC (NRT2-B3300)
- the UPS has been shut down completely and all isolation switches are OFF;
- switches upstream of the UPS are OFF.



When connecting the UPS to the battery extension, use only the cable provided with the equipment.



Any wiring error that results in the polarity of the battery being inverted can cause permanent damage to the equipment.

- Set the switch on the back of the battery extension module to the OFF position.
- Connect the battery extension module to the UPS.
- Set the switch on the back of the battery extension module to the ON position.
- Set the number of EBM connected to the UPS on setting menu.

5. CONNECTION OF BATTERY EXTENSION

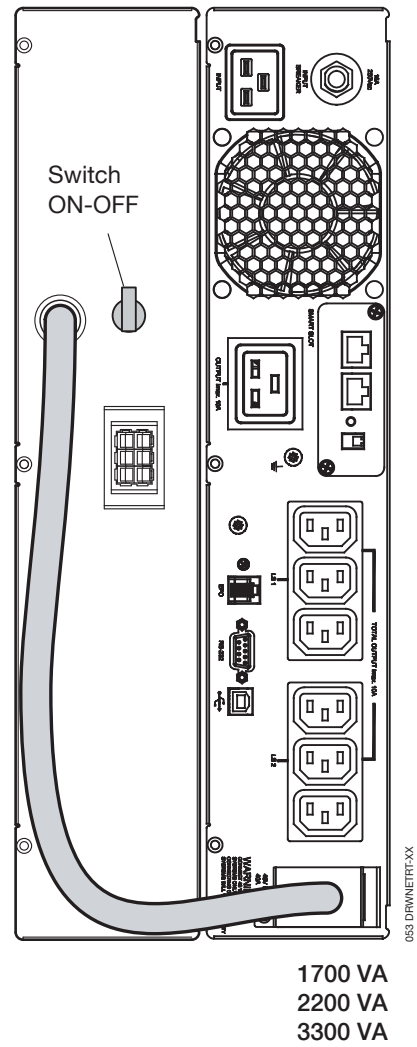
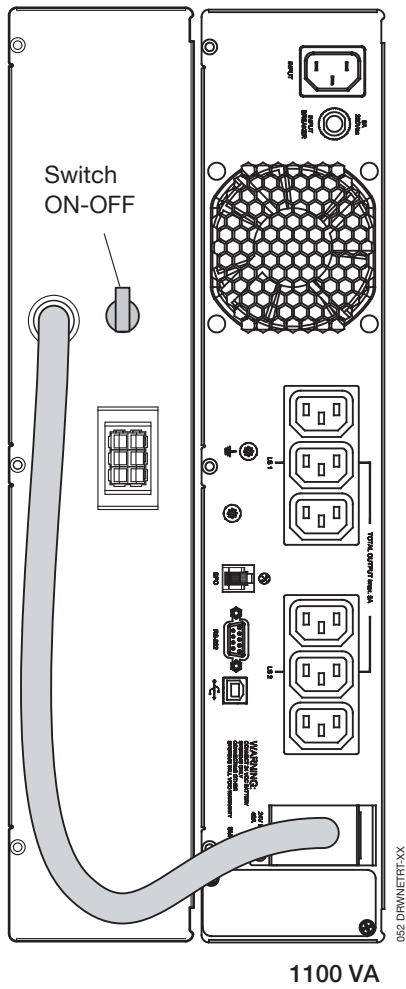

Connection of multiple batteries

	Max EBM	
		with additional charger
NRT2-U1100	2	/
NRT2-U1700	2	up to 10
NRT2-U2200	2	up to 10
NRT2-U3300	2	up to 10

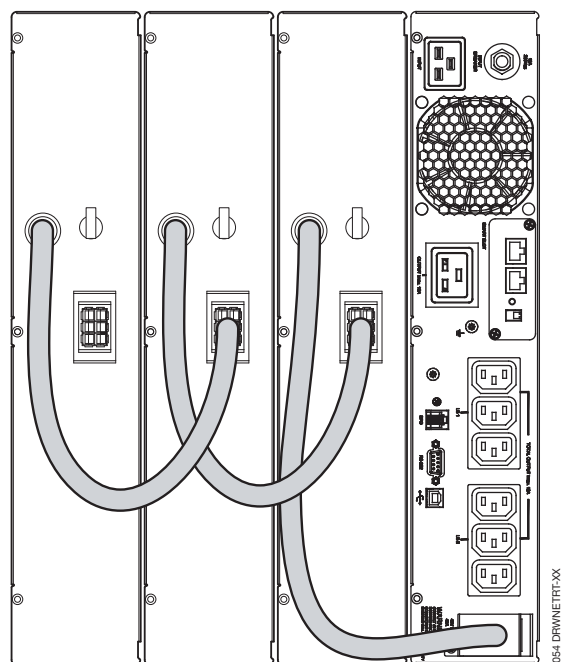

6. MIMIC PANEL

The mimic panel on the front of the UPS provides all essential information on the operating status of the appliance.

Legend

A LED

- Green - Normal operation.
- Yellow- Alarm
- Red - Load not supplied

B LCD display

C Scroll button

D On button

E Off button

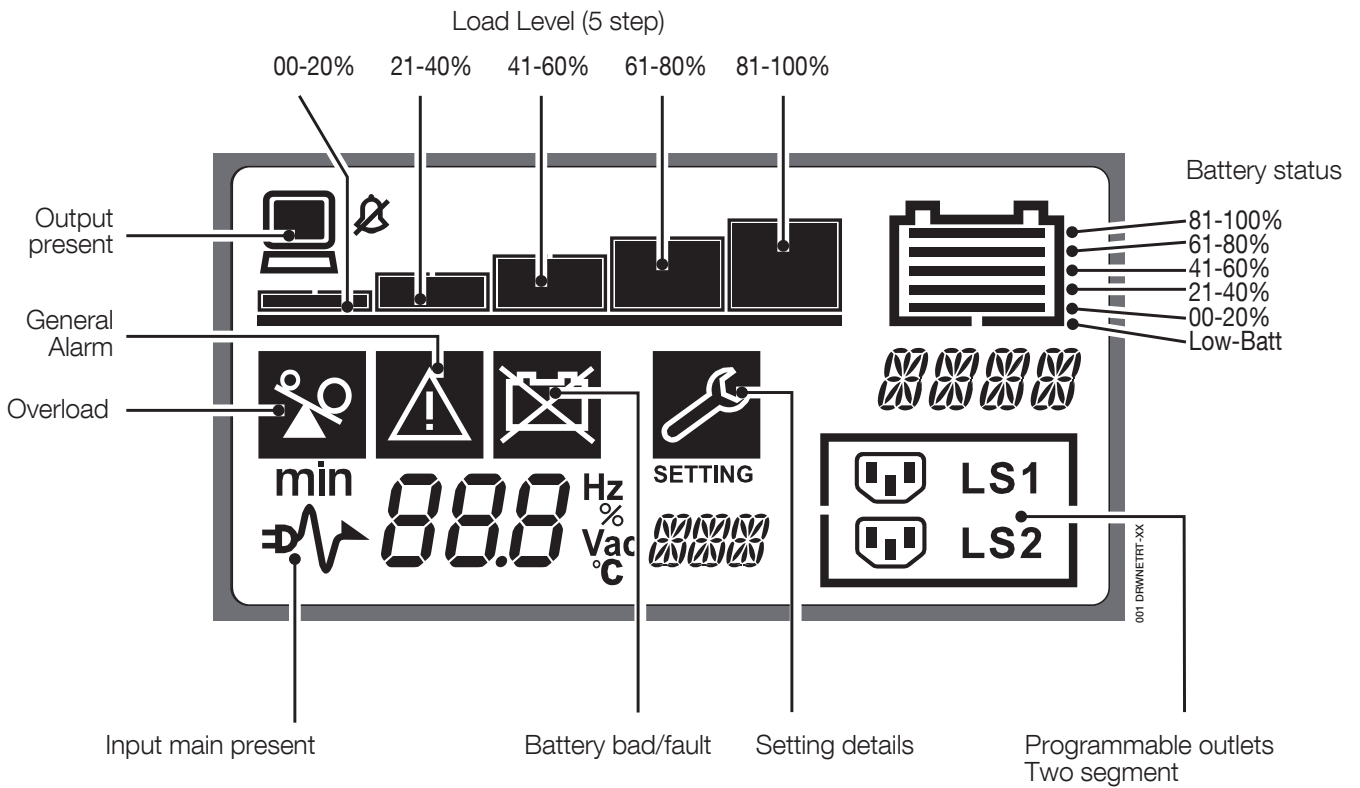
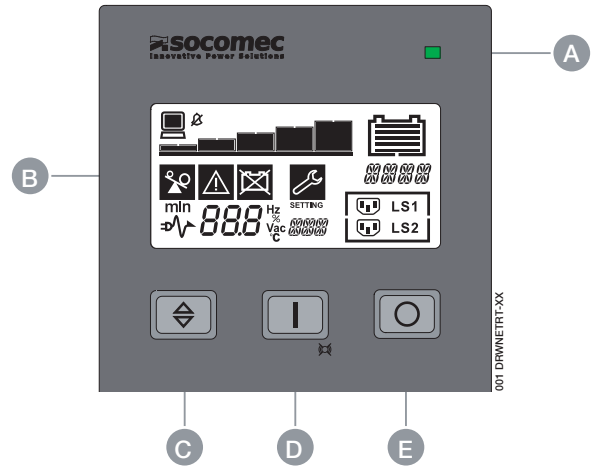

7. OPERATING MODES

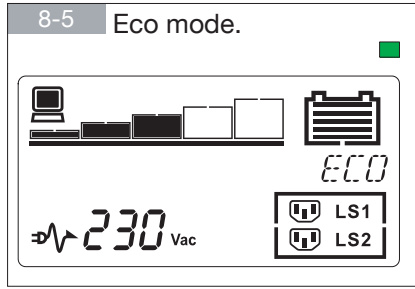
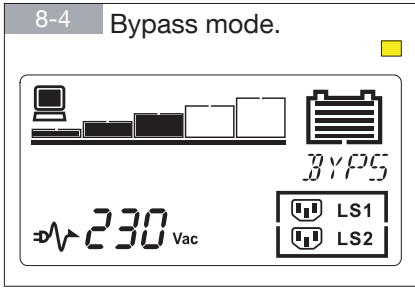
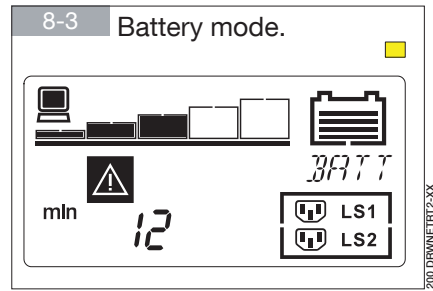
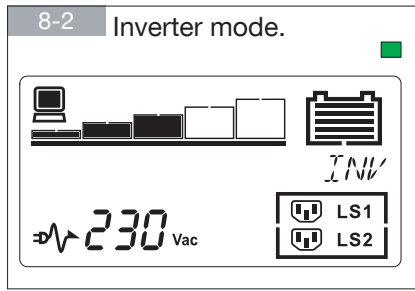
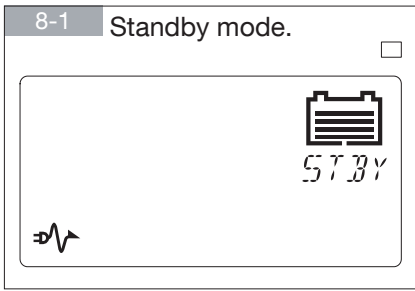

7.1 BATTERY RECHARGE

Connect the UPS to the mains voltage for approximately 8 hours to recharge the internal batteries.

The UPS can be used even with the batteries not fully charged, though if a power outage should occur, the duration of the backup will be shorter.

7.2 SWITCHING THE UPS ON AND OFF

7.2.1 Switching on with mains present

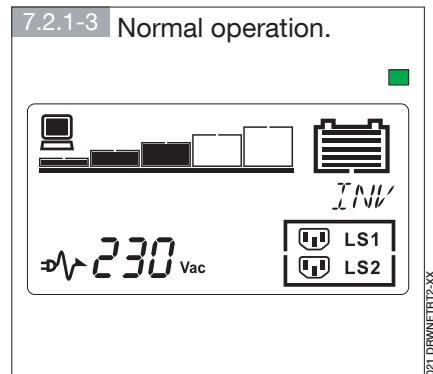
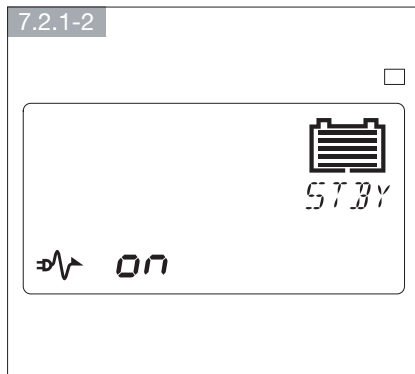
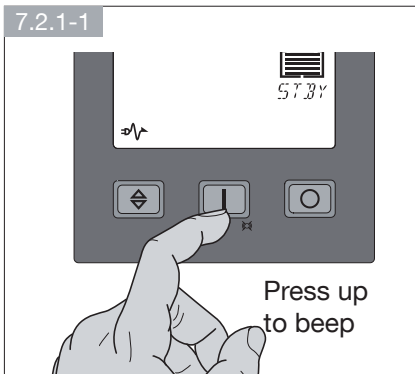

Power up all loads, one at a time.

7.2.2 Switching on with no mains power (Cold Start)

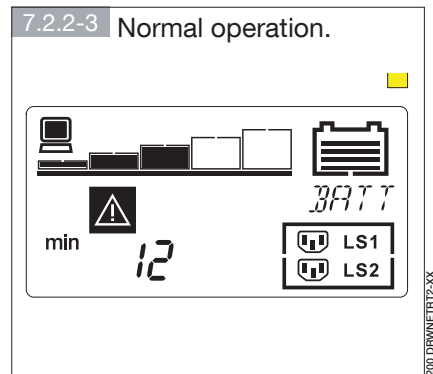
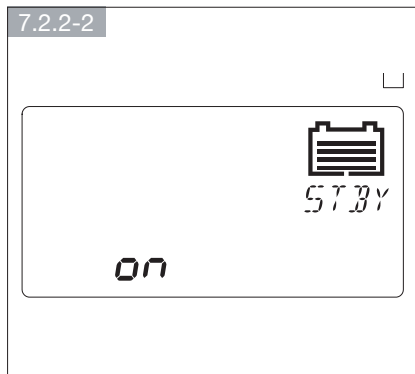
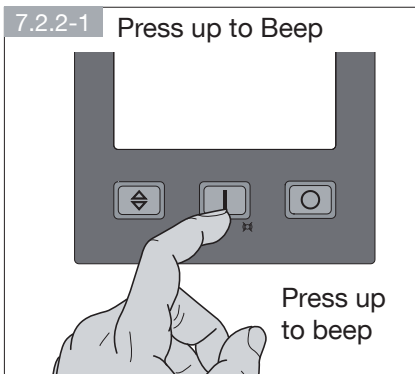

Power up all loads, one at a time.

7.2.3 Switching off with mains present

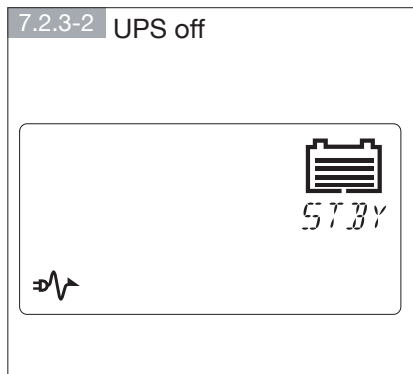

- UPS is off but battery remains on charge
- Shut down all loads, one at a time.
- Switch off mains power to shut down completely.

7.2.4 Buzzer override

Press the ON/TEST button to activate/deactivate (Battery mode) the buzzer

7.3 BATTERY TEST

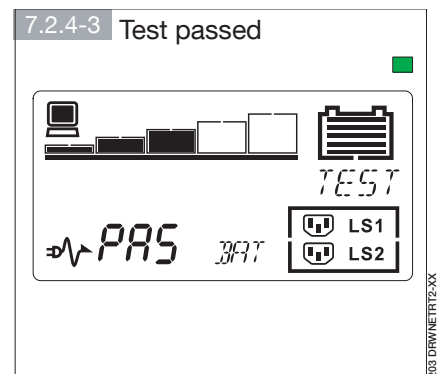
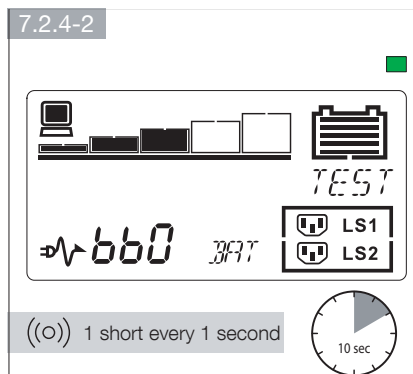
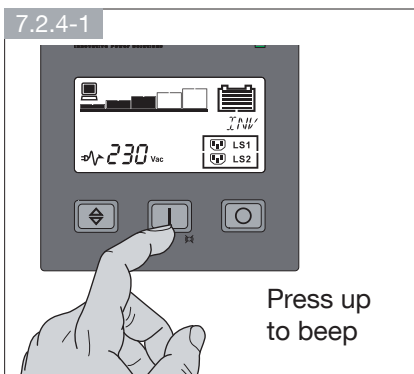

8. VISUAL AND AUDIBLE WARNING SIGNALS

8-1 Overload warning.

((o)) 1 Short every seconds ■

INV
LS1
LS2

105 % PWR

010 DRWNETRT2-XX

8-2 Overload with Bypass

((o)) 1 Short every seconds ■

BYPASS
LS1
LS2

121 % PWR

023 DRWNETRT2-XX

8-3 Overload without Bypass

((o)) 1 Short every seconds ■

OFF
LS1
LS2

121 % PWR

204 DRWNETRT2-XX

8-4 Battery needs replacing.

((o)) 1 Short every seconds ■

INV
LS1
LS2

230 Vac

021 DRWNETRT2-XX

UPS Error

8-5 Fan failure.

((o)) 5 second ■

INV
LS1
LS2

E12 ERR

023 DRWNETRT2-XX

8-6 Overtemperature.

((o)) 5 second ■

BYPASS
LS1
LS2

E13 ERR

019 DRWNETRT2-XX

8-7 Short-circuit on output.

((o)) continuous ■

OFF
LS1
LS2

E21 ERR

011 DRWNETRT2-XX

UPS Shutdown

8-8 Emergency Power Off EPO.

((o)) 5 second ■

LS1
LS2

EPO

014 DRWNETRT2-XX

8-9 Remote Power Off RPO.

((o)) 5 second ■

LS1
LS2

RPO

014 DRWNETRT2-XX

8-10 Battery save Shutdown Green function.

((o)) 5 second ■

LS1
LS2

OFF

014 DRWNETRT2-XX

8-11 Shutdown caused by flat battery.

((o)) 5 second ■

LS1
LS2

OFF

Sd4

014 DRWNETRT2-XX

8-12 Cold start Shutdown low battery.

((o)) 5 second ■

LS1
LS2

OFF

Sd5

014 DRWNETRT2-XX

9. SETTINGS

9.1 SETTING MENU



WARNING!

Wrong configuration in UPS SETTINGS could damage the load or the batteries.
Please refer to after sales support for clarification.

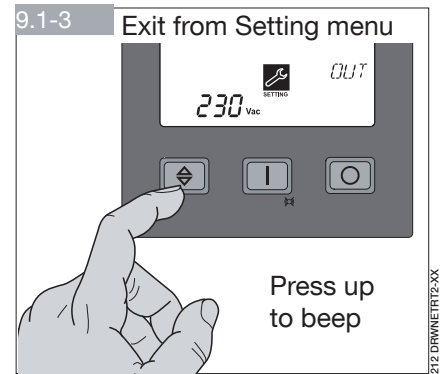
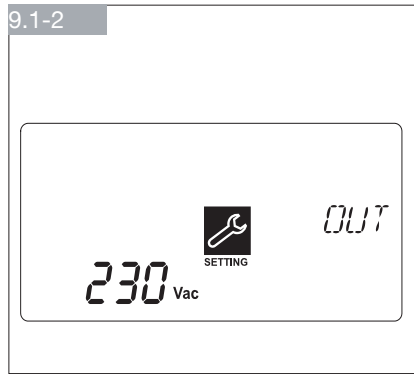
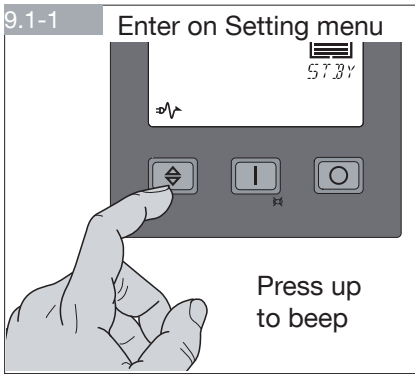

9.2 SETTINGS

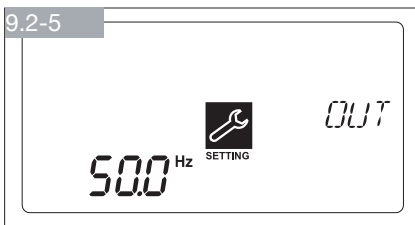
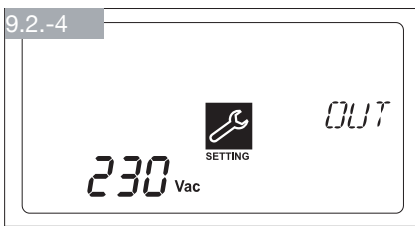
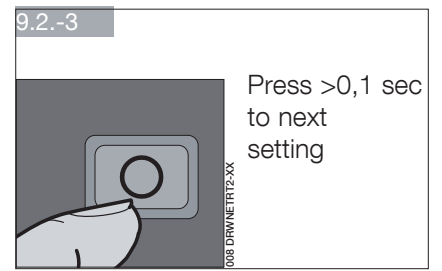
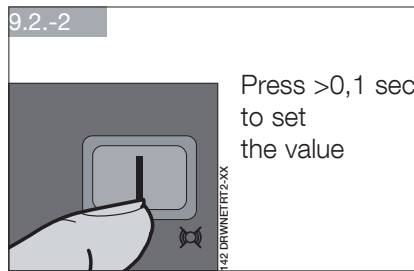
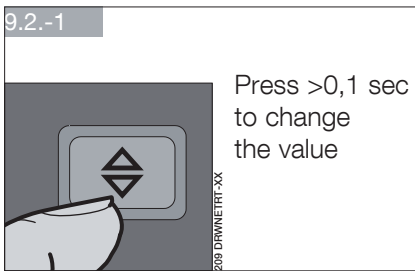

Description	Value	Default
Set the nominal output voltage (V)	200/ 208/ 220/ 230/ 240	230
Set the output frequency (Hz)	50/ 60	50
Bypass voltage tolerance window on nominal output	0%/ 5%/ 10%/ 15%/ 20%/ HI (as input mains)	10

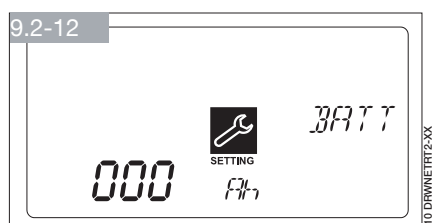
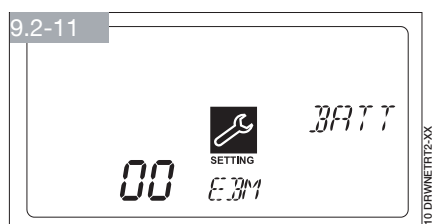
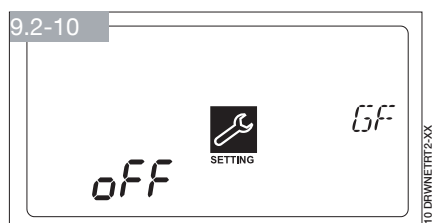
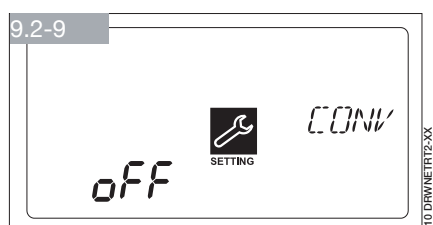
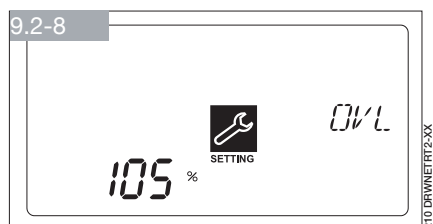
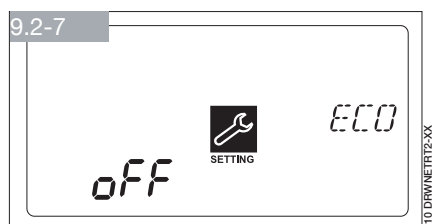

Description	Value	Default
Enable the eco mode function	on/ off	off
Set overload value Allow to set the overload alarm level (% of nominal power)	5/ 10/ 15/... 105	105
Enable frequency converter mode	on/ off	off
Enable Green function if enabled, this function switch off the UPS at the following condition: <ul style="list-style-type: none"> • Mains absent • Load rate lower than 8% 	on/ off	off
Set number of external battery module (EBM) refer to battery extension chapter	0/ 1/ ...10	0
Set the Ah of customised battery bank	0/ 1/ ...999	0
Enable the buzzer If off, an icon appear on display	on/ off	on

10. COMMUNICATION

Communication software and accessories are available for monitoring the status of the UPS, with the end in view of optimizing normal operation and ensuring that shutdown at the end of backup time is managed correctly. Applications allow recording of all power outages and any depletion of battery power so as to enable the activation of an automatic procedure for closing programs in ordered sequence and shutting down the system.

NETYS RT no-break systems are equipped with RS232 and USB serial communication interfaces, and slots for Web/SNMP cards.

10.1 COMMUNICATION SOLUTIONS

- **Local View** ideal UPS monitoring and shutdown point-to-point solution for Windows®, Linux® and Mac OS X® operating systems.
- **Web/SNMP manager** (Web/SNMP slot card) allowing control via LAN using TCP/IP protocol, and remote shutdown management.
- **BMS** (JBUS-RS232 interface), allows the UPS to interface with a Building Management system.

10.2 USB INTERFACE

The UPS can communicate with the server direct by way of the USB interface using HID protocol, if available on the computer operating system, without the need to install any additional software. Once connected, recognition of the UPS occurs in the same way as for any other peripheral, and the operating parameters can be managed by way of the OS service menu. Use the connecting cable provided.

10.3 RS232 INTERFACE

This interface is required to run Local View ideal UPS monitoring and shutdown point-to-point solution for Windows®, Linux® and Mac OS X® operating systems.

10.4 EPO PORT

The EPO (emergency power off) port allows the user to shut down the UPS in online mode or in battery mode when an emergency occurs. Use a RJ11 cable (not provided) to connect the EPO port and a user-supplied switch.

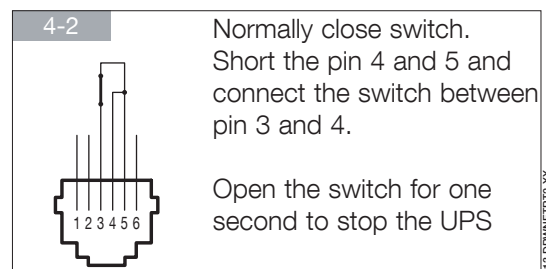
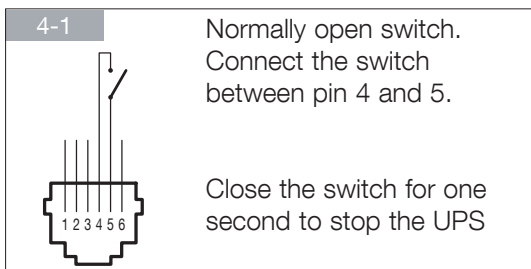

10.5 WEB/SNMP CARD (OPTION)

With this card installed, the UPS can be connected directly to a LAN (RJ45 ethernet) and controlled remotely from a WEB browser using TCP/IP protocol. Reference should be made to the dedicated literature for a full description of the functionalities.

10.6 USE OF WARNING RELAY INTERFACE

This is an optional card (slot-mounted) that will manage 6 indication circuits with isolated contacts carrying information on the status of the UPS. The maximum voltage that can be applied to the contacts is 24 VDC, and the maximum current 500 mA.

Relay contacts can be set individually for NO (default) or NC operation, and programmed selectively for customized monitoring of the UPS.

If requested, the UPS can also be switched off utilizing a remote external shutdown contact. The command is acknowledged when the contact is made and held for 3 seconds (default), whereas the external contact must be made between the common and input pins.



The external contact **MUST** be dedicated and voltage-free, so as not to cause permanent damage to the UPS.

The shutdown input can be configured alternatively as a battery test input.

10.6.1 Internal circuit

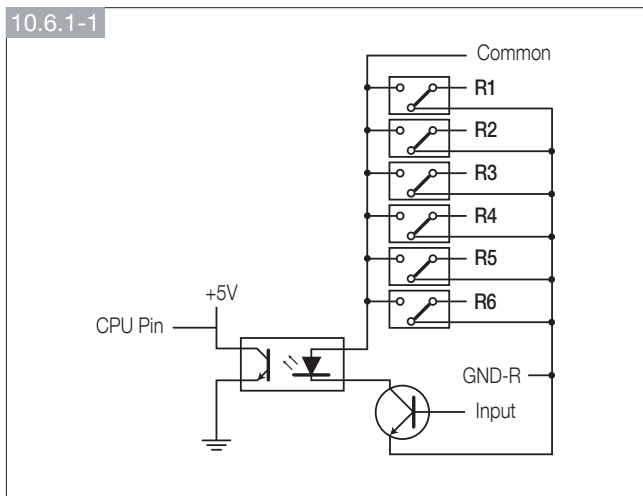

058 DRWNETRT-XX

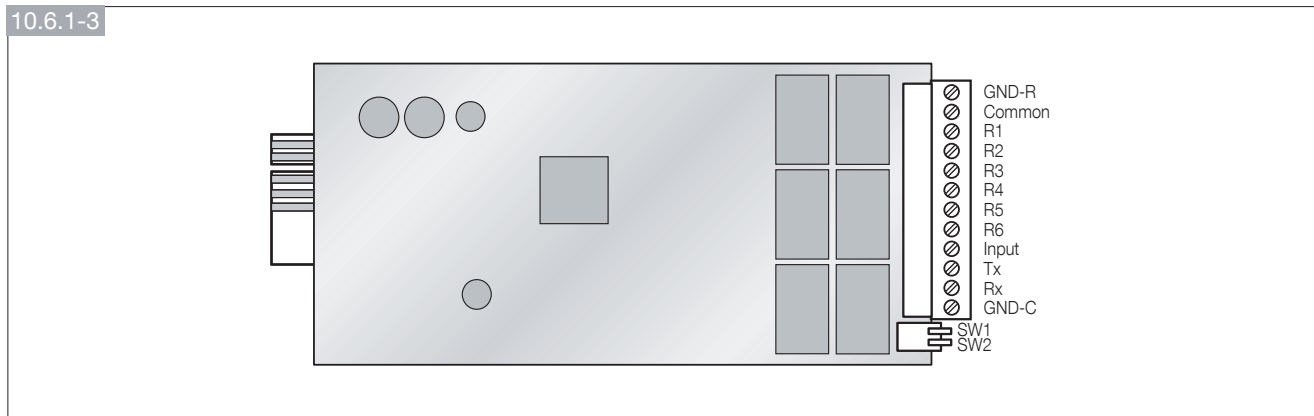
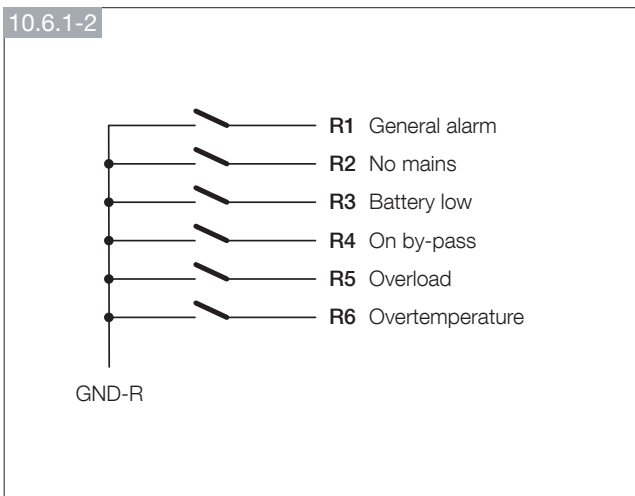

058 DRWNETRT-XX

10.6.2 Standard configuration

SW1	SW2	relay contact
OFF	OFF	NO
ON	OFF	NC

GND-R: Relay ground contact	
Common: 12~24 V DC	
R1	General alarm
R2	No mains
R3	Battery low
R4	On by-pass
R5	Overload
R6	Overtemperature
Input: Remote shutdown or battery test	

10.6.3 Customized configuration for relay and/or input contacts

Connect **Tx** to pin 2, **Rx** to pin 3 and **GND-C** to pin 5 of the computer's RS232 port.

In Windows, start the Hyper-Terminal application and proceed to open the specified COM port.

Set the following properties: Baud rate: 2400, Data Bits: 8, Parity: None, Stop Bit: 1, Flow Control: None.

• Configuration.

Press <Enter> to display the main menu of the relay card.

1. Press '1' to configure the alarms relative to contacts **R1~R6 (Customize Output Relay)**.

This menu can be used to assign a customized alarm indication to contacts **R1~R6**.

Having completed the configuration, shift **SW2** to the ON position to activate the settings. The default settings can be restored by setting **SW2** to OFF.

2. Press '2' to configure the **input** signal.

The input signal can be used either to shut down the UPS or to test the batteries. The delay preceding shutdown of the UPS can be set up to 9999 seconds maximum.

3. Press '3' to configure NO or NC operation of each relay.

Shift **SW2** to the ON position to activate the settings.

If SW2 is returned to the OFF position, SW1 can be used to check the NO or NC position of all the relays.

4. Press '0' to end the configuration session. The system will prompt you to save the new settings.

Press 'Y' to save, 'N' to cancel.

UPS Relay Card

Firmware Version: Relay Card V1.4

- [1] . Customize Output Relay
- [2] . Configure Input Signal
- [3] . Customize Normal Open or Normal Close
- [0] . Quit

Please Enter Your Choice >

Customize Output Relay

Relay Selected Event

- [1] . Relay 1: Summary Alarm
- [2] . Relay 2: Power Fail
- [3] . Relay 3: Battery Low
- [4] . Relay 4: On by-pass
- [5] . Relay 5: Overload
- [6] . Relay 6: Overtemperature
- [0] . Back to Previous Menu

Please Enter Your Choice >

Customize Output Relay

Relay Selected Event

- [1] . Relay 1: Normal Close
- [2] . Relay 2: Normal Open
- [3] . Relay 3: Normal Close
- [4] . Relay 4: Normal Open
- [5] . Relay 5: Normal Close
- [6] . Relay 6: Normal Open
- [0] . Back to Previous Menu

Please Enter Your Choice >

Configure Input Signal

- [1] . Act as Shutdown or Test: Shutdown
- [2] . Input Signal Confirm 3 Seconds
- [3] . Delay Before Shutdown 30 Seconds
- [0] . Back to Previous Menu

Please Enter Your Choice >

11. MAINTENANCE



WARNING!

The UPS generates HAZARDOUS INTERNAL VOLTAGES. All maintenance operations should be carried out by AUTHORIZED SERVICE ENGINEERS ONLY.

- The unit will operate to its maximum capability if kept powered up round the clock (24/7); this ensures that the batteries will always be properly charged.
- If the appliance is to remain idle for any length of time, wait until the batteries are fully charged (connection to mains power supply for 8 hours continuous) before shutting the UPS down.
- Recharge the batteries for a duration of 24 hours at least every 4 weeks during the time the unit remains idle.

11.1 MINOR TROUBLESHOOTING



WARNING!

If problems should persist or reoccur frequently after following the procedures indicated in this section, contact the SOCOMECE After Sales Service, providing a full description of the current difficulty

Problem	Possible cause	Solution
"UPS not powered up (no alarm, no display)	No mains present	Check if mains is present or distribution switch are closed
	The ON/TEST button has not been pressed.	Press the ON/TEST button to switch the UPS on.
	Shutdown due to flat battery and no mains power.	Wait for mains power to be restored
	Thermal switch on the rear panel has been tripped.	Reduce the load connected to the UPS, then reset the thermal-magnetic switch.
UPS does not guarantee the expected backup time.	Faulty UPS	Contact SOCOMECE After Sales Service if the solutions indicated above do not solve the problem.
	UPS internal batteries not completely charged.	Recharge the batteries for a minimum of 8 hours.
	UPS in overload.	Disconnect non-essential loads.
	Depleted batteries.	The batteries will degrade quickly if used frequently, or in high operating temperatures. Should the batteries have reached the end of their life cycle, contact SOCOMECE After Sales Service. Batteries must be replaced even if the "Replace battery" LED is not lit.
"Replace battery" icon lit.	Battery charge fault or other causes.	Contact SOCOMECE After Sales Service
	Batteries flat.	Charge the batteries for a minimum of 8 hours. If the problem persists, contact SOCOMECE After Sales Service to have for battery replacement.
Faulty communication between PC and UPS.	Wrong transmission speed.	Change the transmission speed and test again.
	RS232 connection incorrect.	See "Communication" section of this manual. Reconnect the UPS to the COM1/COM2 port of the PC.
	USB connection incorrect.	Reconnect the UPS to the USB port of the PC.
UPS functions in "Battery Mode" even though a.c. mains is connected and healthy.	Mains voltage not registering at UPS input.	Check the input voltage connection.
	Thermal switch on the rear panel has been tripped.	Reduce the load connected to the UPS, then reset the thermal-magnetic switch.
	Input voltage too high, too low or distorted.	Have the mains voltage checked by a qualified electrician.
Fan Failure E12	Air intake fans and fan cowl may be obstructed.	Cleanup the fan intake and fan cowl
Overtemperature. E13	Air intake fans and fan cowl may be obstructed.	Select a well ventilated area in which to position the UPS, allowing suitable dissipation of heat.
	Ambient temperature is higher than 40 °C (104 °F).	Position the UPS in a cooler area.

<i>Problem</i>	<i>Possible cause</i>	<i>Solution</i>
<i>ERR E11, E12, E14, E16, E18, E19.</i>	<i>UPS faulty.</i>	<i>Contact SOCOMEC After Sales Service.</i>
<i>"Overload" icon lit, with continuous alarm signal.</i>	<i>Overload.</i>	<i>Disconnect non-essential loads.</i>
<i>Short circuit E21</i>	<i>A short circuit is detected on the output</i>	<i>Remove the short circuit on the load and restart the UPS</i>
<i>Sd0</i>	<i>EPO shutdown</i>	<i>UPS is off because of Emergency Power OFF button. Check that all emergency condition has been solved, and restart the UPS.</i>
<i>Sd1</i>	<i>RPO shutdown</i>	<i>Nothing to do, UPS is off due to software scheduled power off, UPS restart automatically at the programmed time</i>
<i>Sd3</i>	<i>Green function shutdown: UPS protect the battery due to low load <8% and GF setting is ON</i>	<i>Restart the UPS if the load is lower than 8% of nominal power, set GF OFF on settings menu</i>
<i>Sd4</i>	<i>Battery low shutdown: mains is absent and UPS switch off for minimum battery</i>	<i>Check mains supply and upstream switch</i>
<i>Sd5</i>	<i>Cold start Shutdown for low battery</i>	<i>Connect UPS to mains to recharge the battery</i>

12. TECHNICAL SPECIFICATIONS

Models		NRT2-U1100	NRT2-U1700	NRT2-U2200	NRT2-U3300
Nominal Power	VA W	1100 VA 900 W	1700 VA 1350 W	2200 VA 1800 W	3300 VA 2700 W
Input/Output phases		1/1			
Electrical Specifications - Input					
Input	Vin	1P+N 230 V (175-280 V) up to 100 V @33% load;			
Input frequency	Hz	50/60			
Input socket		IEC 320-C14 (10 A)	IEC 320-C20 (16 A)		
Power factor		0.99			
THDI		<6%			
Electrical Specifications - Output					
Output	V	1P+N 230 V nominal $\pm 2\%$ (selectable: 200 ⁽¹⁾ /208 ⁽¹⁾ /220/240 V); 50/60 Hz			
Efficiency on line mode		up to 90%	up to 93%		
Overload capability		up to 105% continuously; 125% x 3 min; 150% x 30 sec			
Output socket		6 x IEC 320-C13 (10 A)	6 x IEC 320-C13 (10 A) + 1 x IEC 320-C19 (16 A)		
Crest Factor		3:1			
Voltage distortion		< 5 % Non Linear Load; < 1.6 % Linear Load			
Converter mode derating	%	50	70		
Batteries					
Type		Maintenance-free sealed lead - life expectancy 3-5 years			
Voltage	V	24	48	48	72
Typical backup ⁽²⁾	min.	8	12	8	10
Recharge time	Hour	<5 to recover 90% capacity			
Charger	A	1.5	1.6	1.6	1.6
Communication					
Connection interface		RS 232, USB port and slots for optional board			
Ethernet		WEB / SNMP interface (Optional)			
Environment					
Operating temperature	°C	0 to 40 (15 to 25 for maximum battery life)			
Relative humidity	%	5 to 95 without condensation			
Max. altitude	m	0 - 3000 without derating			
Noise level at 1 m	dBA	<45	<50	<50	<51
Standards					
Safety		EN 62040-1, EN 62040-2 ⁽³⁾			
EMC ⁽⁴⁾		EN 62040-2 C1	EN 62040-2 C2		
Product Certification		CE			
Protection Level		IP20			
Mechanical Characteristics with standard batteries					
Dimensions WxDxH	mm inch	440x332x88.7 17,3"x13,2"x2U	440x430x88.7 17,3"x19"x2U	440x608x88.7 17,3"x24"x2U	
Weight	kg	13	18	19	30
⁽¹⁾ @ 200 and 208 Vac Pout = 90% Pnom. ⁽²⁾ @ 75% Pnom. ⁽³⁾ With output cables shorter than 10 m.					



Socomec worldwide

IN EUROPE

BELGIUM

UPS / Power Control & Energy Efficiency / Solar

Tel. +32 2 340 02 30
Fax +32 2 346 28 99
info.be@socomec.com

FRANCE

UPS / Power Control & Energy Efficiency / Solar

Tel. +33 1 45 14 63 00
Fax +33 1 48 67 31 12
dcm.ups.fr@socomec.com

GERMANY

Power Control & Energy Efficiency

Tel. +49 7243 65292 0
Fax +49 7243 65292 13
info.scp.de@socomec.com

UPS

Tel. +49 621 71 68 40
Fax +49 621 71 68 444
info.ups.de@socomec.com

ITALY

Power Control & Energy Efficiency

Tel. +39 02 98 49 821
Fax +39 02 98 24 33 10
info.scp.it@socomec.com

Solar

Tel. +39 0444 598611
Fax +39 0444 598627
info.solar.it@socomec.com

UPS

Tel. +39 02 98 242 942
Fax +39 02 98 240 723
info.ups.it@socomec.com

NETHERLANDS

UPS / Power Control & Energy Efficiency / Solar

Tel. +31 30 760 0900
Fax +31 30 637 2166
info.nl@socomec.com

POLAND

Power Control & Energy Efficiency

Tel. +48 91 442 64 11
Fax +48 91 442 64 19
info.scp.pl@socomec.com

UPS

Tel. +48 22 825 73 60
Fax. +48 22 825 73 60
info.ups.pl@socomec.com

PORTUGAL

UPS / Solar

Tel. +351 261 812 599
Fax +351 261 812 570
info.ups.pt@socomec.com

ROMANIA

UPS / Power Control & Energy Efficiency / Solar

Tel. +40 21 319 36 88
Fax +40 21 319 36 89
info.ro@socomec.com

RUSSIA

UPS / Power Control & Energy Efficiency / Solar

Tel. +7 495 775 19 85
Fax +7 495 775 19 85
info.ru@socomec.com

SLOVENIA

UPS / Power Control & Energy Efficiency / Solar

Tel. +386 1 5807 860
Fax +386 1 561 11 73
info.si@socomec.com

SPAIN

UPS / Power Control & Energy Efficiency / Solar

Tel. +34 93 540 75 75
Fax +34 93 540 75 76
info.es@socomec.com

UNITED KINGDOM

Power Control & Energy Efficiency

Tel. +44 1462 440 033
Fax +44 1462 431 143
info.scp.uk@socomec.com

UPS

Tel. +44 1285 863 300
Fax +44 1285 862 304
info.ups.uk@socomec.com

TURKEY

UPS / Power Control & Energy Efficiency / Solar

Tel. +90 216 540 71 20-21-22
Fax +90 216 540 71 27
info.tr@socomec.com

IN ASIA PACIFIC

AUSTRALIA

UPS

Tel. +61 2 9325 3900
Fax +61 2 9888 9544
info.ups.au@socomec.com

CHINA

UPS / Power Control & Energy Efficiency

Tel. +86 21 52 98 95 55
Fax +86 21 62 28 34 68
info.cn@socomec.com

INDIA

Power Control & Energy Efficiency

Tel. +91 124 4027210
Fax +91 124 4562738
info.scp.in@socomec.com

UPS / Solar

Tel. +91 44 39215400
Fax +91 44 39215450 & 51
info.ups.in@socomec.com
info.solar.in@socomec.com

SINGAPORE

UPS / Power Control & Energy Efficiency

Tel. +65 6506 7600
Fax +65 64 58 7377
info.sg@socomec.com

THAILAND

UPS

Tel. +66 2 941 1644 7
Fax +66 2 941 1650
info.ups.th@socomec.com

VIETNAM

UPS

Tel. +84 8 3559 1220
Fax +84 8 3559 1221
info.ups.vn@socomec.com

IN MIDDLE EAST

UNITED ARAB EMIRATES

UPS / Power Control & Energy Efficiency / Solar

Tel. +971 4 29 98 441
Fax +971 4 29 98 449
info.ae@socomec.com

IN AMERICA

USA, CANADA & MEXICO

Power Control & Energy Efficiency

Tel. +1 617 245 0447
Fax +1 617 245 0437
info.us@socomec.com

OTHER COUNTRIES

NORTH AFRICA

Algeria / Morocco / Tunisia
info.naf@socomec.com

AFRICA

Other countries
info.africa@socomec.com

SOUTH EUROPE

Cyprus / Greece / Israel / Malta
info.se@socomec.com

SOUTH AMERICA

Tel. +34 93 540 75 75
info.es@socomec.com

MORE DETAILS

www.socomec.com/worldwide

HEAD OFFICE

SOCOMECC GROUP

S.A. SOCOMECC capital 10 816 800€
R.C.S. Strasbourg B 548 500 149
B.P. 60010 - 1, rue de Westhouse
F-67235 Benfeld Cedex - FRANCE
Tel. +33 3 88 57 41 41
Fax +33 3 88 74 08 00
info.scp.isd@socomec.com

www.socomec.com

YOUR DISTRIBUTOR



I0MNETRTXX0B-EN 01 07.2015



socomec
Innovative Power Solutions