

CONVERTER

RS232 <=> RS485

Operating instructions

GB

MAKE YOUR BUSINESS SAFE



GENERAL INFORMATION	3
Safety	3
Maintenance	3
Introduction	3
APPROVALS AND CONFORMITY	4
Declaration of conformity	5
SPECIFICATIONS	6
Environmental conditions and type tests	6
Main features	8
INSTALLATION	9
Mounting/removal	9
Connections	10
LED Indicators	10
DIP switch settings	11
FUNCTIONAL DESCRIPTION	13
Field of application	13
APPLICATION EXAMPLE	15

GENERAL INFORMATION

RS232 <=> RS485

Safety

IMPORTANT NOTE TO BE READ BEFORE INSTALLATION

 Read the manual carefully and ensure you have fully understood its contents before operating this equipment for the first time.

Check that your application meets the equipment's technical specifications for operation.

Dangerously high voltage levels can be produced when this equipment is connected to the power supply or TNV circuits.

To prevent electric shocks, the equipment must be disconnected from the power supply and all other electrical connections.

You are recommended to ground yourself to avoid electrostatic discharge (ESD) damage to internal components (e.g.: wear electrostatic bracelets).

BEFORE INSTALLATION

 This equipment must only be installed by qualified technicians.

This equipment is designed for industrial use. It must be installed in an equipment room where access is strictly restricted to authorised personnel.

The power supply must have adequate electrical protection and it must be possible to disconnect the equipment manually.

Ensure that the installation complies with current national regulations.

This equipment uses convection cooling. Ensure to leave sufficient space around the equipment to enable proper airflow (refer to the chapter on installation).

Maintenance

No maintenance is required provided that the equipment is used under the conditions specified.

Introduction

The RS232<=>RS485 converter has been designed to convert signals between an RS232/V.24 interface and an RS485 interface. This equipment is often used in multidrop applications, connected to a PC, automation devices and other industrial equipment.

In 2 wire half-duplex mode (RS485), the converter can automatically control the direction of the transmission on the bus by data flow. In this case, the converter will automatically determine the bus reversal depending on the direction of the data transmitted.

In this way, the converter can also be used to connect equipment which has no handshaking signal.

The maximum data transmission rate is 115.2 Kbit/s.

APPROVALS AND CONFORMITY

RS232 <=> RS485

Type	Accreditation/ Compliance	
EMC standard	EN 61000-6-2 EN 55024 EN 61000-6-3 FCC part 15 EN 50121-4 IEC 62236-4	Immunity for industrial environments Immunity for IT equipment Emission standard for residential environments Class B Railway applications: immunity for signalling and telecommunications apparatus. Railway applications: immunity for signalling and telecommunications apparatus.
Safety	EN 60950	IT Equipment

APPROVALS AND CONFORMITY

RS232 <=> RS485

Declaration of conformity



On-load industrial switches and UPS systems

Testing laboratory
 rue de Westhouse
 B.P. 10
 67235 BENFELD Cedex
 Tel. (33) 03 88 57 41 41 - Telex 870 844
 Fax (33) 03 88 57 42 20

ATTESTATION OF CONFORMITY CE No AC 9849 PRO

Following specifications :
 Manufacturer's specifications

TESTED MATERIAL

Designation : System ensuring the control, management and protection of electrical networks
Type : External RS232 / RS485 interface unit
Reference : 4899 0100
Manufacturer : SOCOMEC S.A. 67230 BENFELD FRANCE

Rated characteristics :

The above-mentioned materials,
-subject to installation, maintenance and use according to its intended purpose, to its regulations, to the standards in force and to the manufacturer's instructions and rules-

Satisfy to the European Low voltage directive n° **73/23/CEE dated 19/02/73** modified by the directive n° **93/68/CEE dated 22/07/93**,

and to the European EMC directive n° **89/336/CEE dated 03/05/89** modified by the directive n° **92/31/CEE dated 28/04/92** modified by the directive n° **93/68/CEE dated 22/07/93**

and to the EN 61000-6-2(2001) ; EN 55024(1998) ; EN 61000-6-3(2001) ; EN 60950(2000)

Year of the CE mark apposition : **2005**

Date : October 17th, 2006

The Writer

Nadine METZ



Test, Standard and Certification Manager

Dominique MARBACH

socomec s.a. au capital de 11 406 652 € - r.c.s. strasbourg B 548 500 149 - siret 548 500 149 00016 - c.c.p. strasbourg 7180 p
 siège social : 1-4, rue de Westhouse - boîte postale 10 - 67230 benfeld france - tél. 03 88 57 41 41 - télécopie 03 88 57 78 78 - Site Web : www.socomec.fr

PCD 03 010585

Archivage : 10 ans par SCP-LAB

NTEER_039_A_GB

SPECIFICATIONS

RS232 <=> RS485

Environmental conditions and type tests

Phenomenon	Standards	Description	Level
ESD Electrostatic discharge	EN 61000-4-2	Unit contact Unit air	± 6 kV ± 8 kV
Modulated electromagnetic radiation (AM)	IEC 61000-4-3	Unit	10 V/m 80% AM (1 kHz), 80 – 1 000 MHz 20 V/m 80% AM (1 kHz), 800 – 960 MHz 20 V/m 80% AM (1 kHz), 1 400 – 2 000 MHz
Electromagnetic radiation 900 Mhz	ENV 50204	Unit	20V/m modulated pulse 200 Hz, 900 ± 5 Mhz
Burst (fast transient)	EN 61000-4-4	Signal ports Supply ports	± 2 kV ± 2 kV
Surge (lightning)	EN 61000-4-5	Unbalanced signal port Balanced signal port Supply ports	± 2 kV line to earth, ± 2 kV line to line ± 2 kV line to earth, ± 1 kV line to line ± 2 kV line to earth, ± 2 kV line to line
HF current injection	EN 61000-4-6	Signal port Supply port	10 V 80% AM (1 kHz), 0.15 – 80 MHz 10 V 80% AM (1 kHz), 0.15 – 80 MHz
Power frequency magnetic field	EN 61000-4-8	Unit	100 A/m, 50 Hz, 16.7 Hz & 0 Hz
Pulse magnetic field	EN 61000-4-9	Unit	300 A/m, 6.4 / 16 pulse
Voltage variation and dips	EN 61000-4-11	AC supply port	10 & 5000 ms interruption 30% 10 & 500 ms reduction 60% 100 & 1000 ms reduction
Power frequency 50 hz	EN 61000-4-16	Signal port	100 V 50 Hz
Power frequency 50 hz	SS 436 15 03	Signal port	250 V 50 Hz
Voltage variation and dips	EN 61000-4-29	DC supply port	10 & 100 ms interruption 10 ms, 30% reduction 10 ms, 60% reduction +20% above & -20% below rated voltage
Radiated emission	EN 55022 FCC part 15	Unit	Class B Class B
Conducted emission	EN 55022 FCC part 15 EN 55022	AC supply port AC supply port DC supply port	Class B Class B Class B
Dielectric strength		Signal ports to all other Supply ports to all other	2 Kv rms 50Hz 1 Min. 3 Kv rms 50Hz 1 Min. 2 Kv rms 50 Hz 1 Min. (@ rated voltage<60V)

Environmental conditions and type tests

ENVIRONMENTAL

Phenomenon	Standards	Description	Level
Temperature		Operating Storage	- 40 to +70°C - 40 to +70°C
Humidity		Operating Storage	5 to 95% relative humidity 5 to 95% relative humidity
Altitude		Operating	2000 m / 70 kPa
MTBF		Operating	10 years
Vibration	IEC 60068-2-6	Operating	7.5 mm, 5 – 8 Hz 2 g, 8 – 500 Hz
Shock	IEC 60068-2-27	Operating	15 g, 11 ms

ENCLOSURE

Phenomenon	Standards	Description	Level
Unit	UL 94	PC / ABS	Flammability class V-1
Dimensions LxHxD			35 x 121 x 119 mm
Weight			0.19 kg
Protection index	IEC 529	Unit	IP 21
Cooling			Convection
Mounting			Horizontal on 35 mm DIN-Rail

SPECIFICATIONS

RS232 <=> RS485

Main features

INPUT SUPPLY

	RS232 <=> RS485
Rated voltage	95 to 240 VAC 110 to 250 VDC
Operating voltage	85.5 to 264 VAC 88 to 300 VDC
Rated current	21 mA @ 95 VAC 10 mA @ 110 VDC
Rated frequency	48 – 62 Hz / DC
Polarity	Independent polarity
Connection	Detachable screw terminal
Conductor size	0.2 – 2.5 mm ² (AWG 24-12)

RS485

Electrical specifications	RS485
Speed	1200 bit/s – 115.2 kbit/s
Data format	7 or 8 bits, Odd, Even or None parity, 1 or 2 stop bit
Connection	Detachable screw terminal
Conductor size	0.2 – 2.5 mm ² (AWG 24-12)
Transmission range	In accordance with EIA RS485 ≤ 1200 m, depending on cable type and speed
Configuration	120 Ω termination and 680 Ω fail-safe biasing by DIP-switch
Protection	Installation Fault Tolerant (up to ± 60 V)

RS232

Electrical specification	RS232-C
Speed	1200 bit/s – 115.2 kbit/s
Data format	7 or 8 bits, Odd, Even or None parity, 1 or 2 stop bit
Connection	9 pin D-sub female DCE
Transmission range	15 m

INSTALLATION

RS232 <=> RS485

Mounting/removal

This equipment must be mounted on a 35 mm DIN-rail, mounted horizontally to a wall or inside an apparatus cabinet.

Snap-on mounting (see figure).

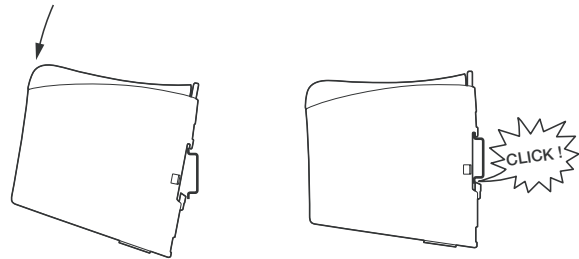

INTER_037_A

COOLING

This equipment uses convection cooling. To optimise the flow of air around the unit, leave sufficient space around the equipment and observe the following instructions:

Recommended space around unit:

- above/below: 25 mm,
- right/left: 10 mm.

It is essential to leave this space around the unit to ensure correct operation across the full range of temperatures and service life.

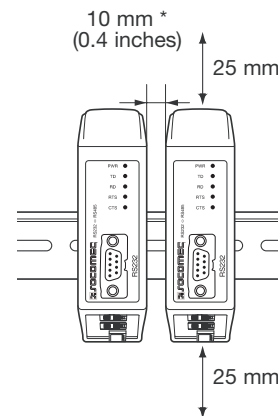

INTER_038_A

* Allow the correct space (Right/Left) to ensure correct operation across the full range of temperatures.

REMOVAL

Press down on the black clip on the top of the unit.
(See figure)

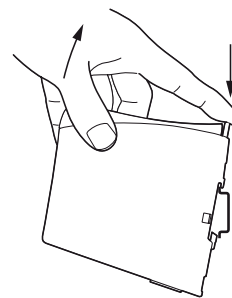

INTER_039_A

INSTALLATION

RS232 <=> RS485

Connections

> RS232 (DCE)

Pos.	Direction	Description
1	-	
2	Output	Received Data (RD)
3	Input	Transmitted Data (TD)
4	-	
5	-	Earth (Signal Ground)
6	Output	Data Set Ready (DSR)
7	Input	Request To Send (RTS)
8	Output	Clear To Send (CTS)
9	-	

> RS485

Pos.	Direction	Description
3	Input/ Output	T-: Line RS485
4	Input/ Output	T+: Line RS485

> Input supply

Pos.	Description	Product marking
1	AC: Neutral DC: Voltage -	N/-
2	AC: Line DC: Voltage +	L/+

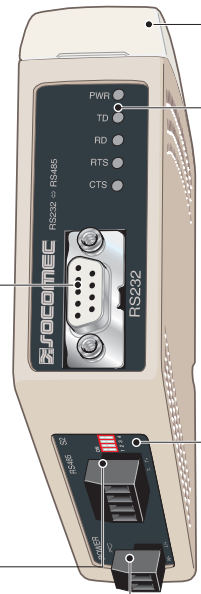

S1 DIP-switch under cap
(for details see page 11)

LED Indicators
(see details below)

S2 DIP-switch
(see details page 11)

LED Indicators

LED	Status	Description
PWR	On Off	Operating Not operating
TD	On Off	Transmitted data: data received from local RS232 port No data transmitted
RD	On Off	Received data: data sent to the RS232 port No data received
RTS	On Off	RTS signal active on RS232 interface RTS inactive
CTS	On Off	CTS signal active on RS232 interface CTS inactive

RAILWAY INSTALLATION CLOSE TO THE RAILS

For a cable located inside 3 m boundary and connected to this port, the use of a shielded cable is recommended, to minimise the risk of interference. The cable shield should be properly connected (360°) to an earthing point within 1 m of this port. This earthing point should have a low impedance connection to the conductive enclosure

of the apparatus cabinet, or similar, if the unit is built-in. This conductive enclosure should be connected to the earthing system of the installation and may be directly connected to the protective earth.

DIP switch settings

S1

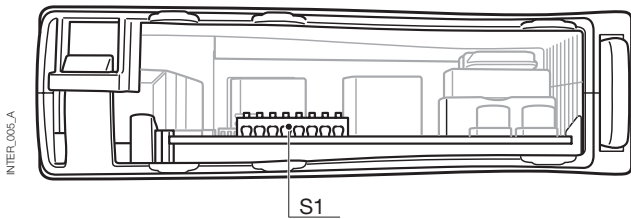

To prevent electric shocks, the equipment must be disconnected from the power supply and all other electrical connections.

> Data rate configuration

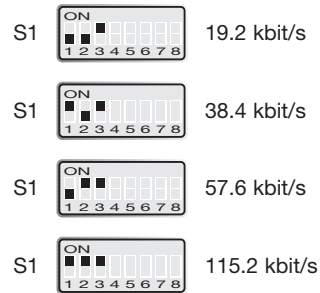
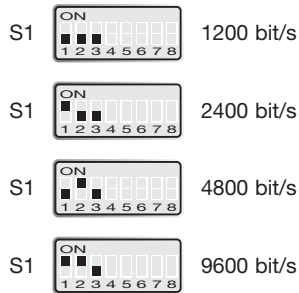

> Data Format Selection

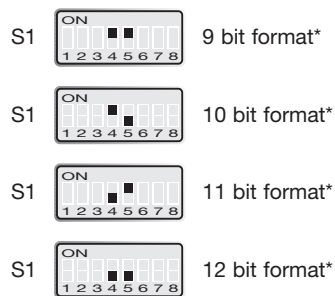

* Refer to the reference table to determine the number of bits.

	9	10	10	10	11	11	11	12
7 Bits	•	•	•		•			
8 Bits				•		•	•	•
No parity	•	•		•		•		
Parity			•		•		•	•
1 stop bit	•		•	•			•	
2 stop bits		•			•	•		•
Number of bits	9	10	10	10	11	11	11	12

> RTS control or data flow

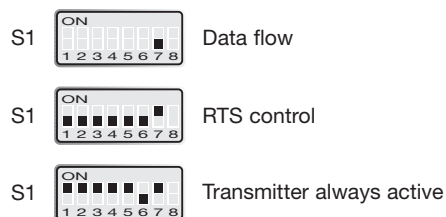

In "RTS control" and "Transmitter always active" modes, the data flow configuration and data format selection switches are not effective.

INSTALLATION

RS232 <=> RS485

DIP-switch settings

S2

> On lower panel, RS485 termination

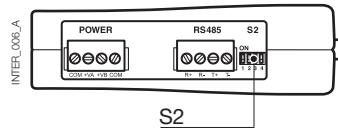
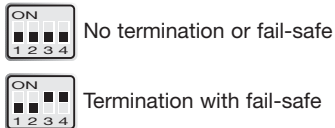

Note: DIP-switch configurations are only effective after the equipment has been switched off and on again.

FACTORY SETTINGS



Note: SW1: 8 not used.

FUNCTIONAL DESCRIPTION

RS232 <=> RS485

When the converter is configured to data flow reversal mode, the transmitter is activated by transmitted data on TD from the RS232.

The transmitter stays active for a period equal to one character time. The reversal time is determined by the transmission format: speed and number of bits. If there is more data to be transmitted after the reversal time has expired, the transmitter will stay active for an additional one character time.

In RTS reversal mode, the transmitter is activated by the RTS signal. In this case, the DIP-switches determining the speed and number of bits are inactive. The LED indicators are controlled by the data signals. The fail-safe terminations will protect the receivers when there is no transmission by forcing them to OFF status. (>0.2 Volts).

Field of application

The RS485 standard is designed for multidrop applications. The system network installed must form a bus structure (see diagram). Star shaped networks are not permitted. To correctly install a RS485 system network, it is essential that terminations are fitted at the corresponding

points. Terminations must be fitted to the receiver on the master unit and the final bus slave unit.

The diagram opposite shows a correct RS485 connection.

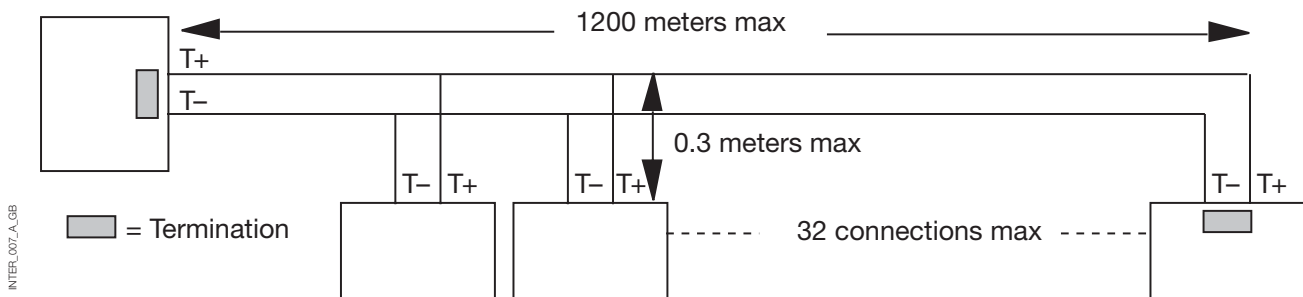

Note: T+/T- are not standard. Connection problems may be resolved by switching the + and - wires if the equipment does not operate correctly.

FUNCTIONAL DESCRIPTION

RS232 <=> RS485

Field of application

LINE CONNECTION

> 2 wires

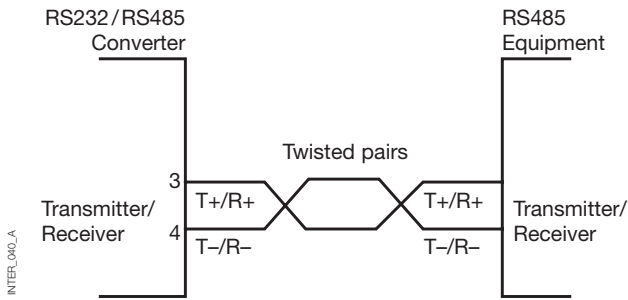

RECOMMENDATIONS FOR USE

Follow the recommendations for use given below to ensure the equipment operates at full performance and to fulfil the terms of the warranty.

- This unit must not be operated with the caps open or removed.
- Do not attempt to dismantle the unit
- There are no serviceable parts inside
- Do not drop, knock, or shake the unit: rough handling or use beyond the recommendations may cause damage to internal circuitry.
- Do not clean the unit using harsh chemicals, cleaning agents or strong detergents.
- Do not paint the unit: paint can block the vents and affect correct operation.
- Do not expose the unit to any type of liquid (rain, drinks, etc.) as the unit is not waterproof. Keep the unit within specified humidity levels
- Do not use or store the unit in dusty or dirty areas: some mechanical components or connectors may be damaged.

APPLICATION EXAMPLE

RS232 <=> RS485

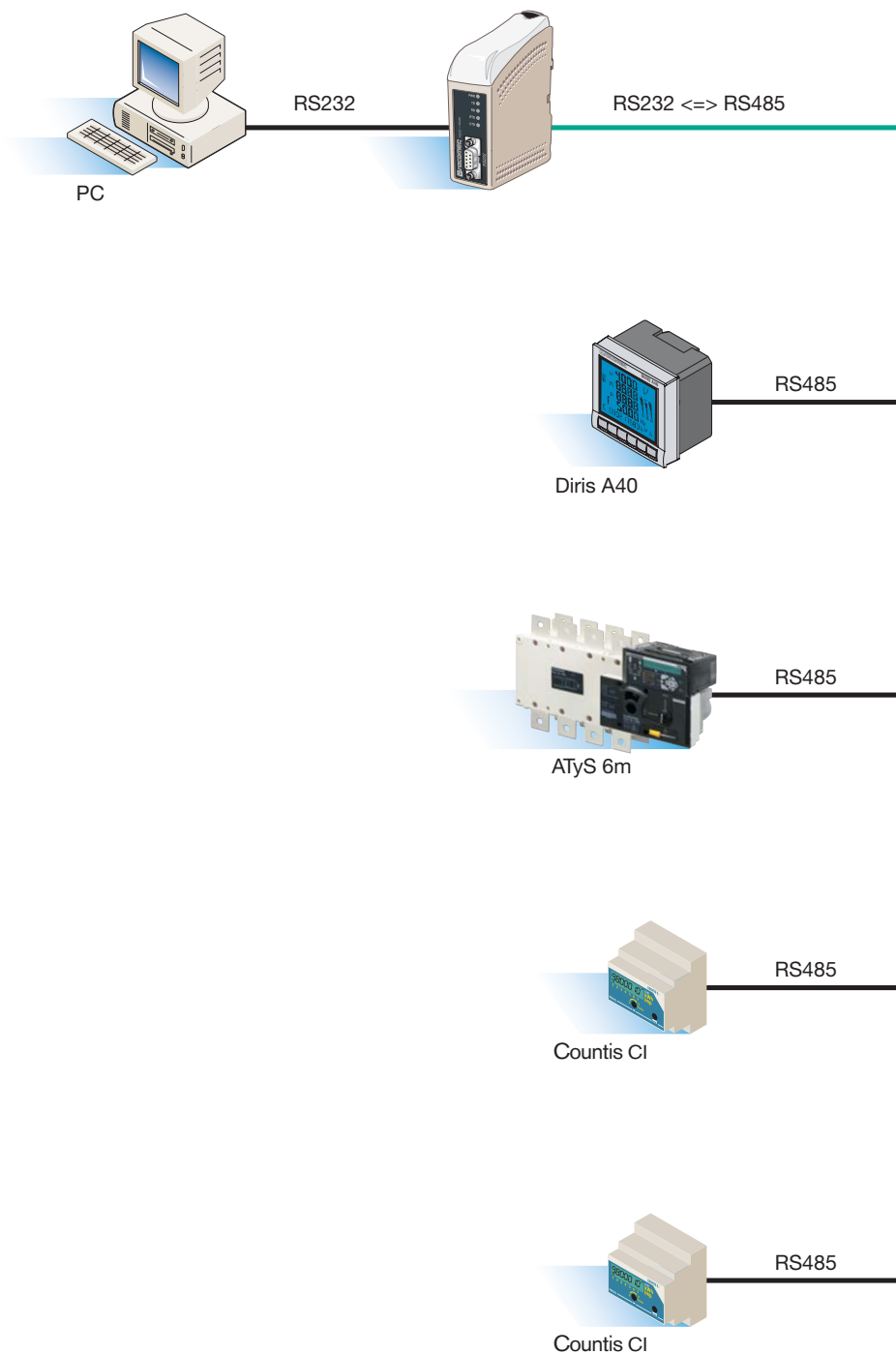

INTER_041.A

HEAD OFFICE

SOCOMEK GROUP SWITCHING PROTECTION & UPS
S.A. capital 11 014 300 €
R.C. Strasbourg 548500 149 B
1, Rue de Westhouse - B.P. 10 - F-67235 Benfeld Cedex - FRANCE

www.socomec.com

INTERNATIONAL SALES DEPARTMENT

SOCOMEK
1, rue de Westhouse - B.P. 10
F - 67235 Benfeld Cedex - FRANCE
Tél. +33 (0)3 88 57 41 41 - Fax +33 (0)3 88 74 08 00
scp.vex@socomec.com

This document is not a contract. SOCOMEK reserves the right to modify features without prior notice in view of continued improvement.