

ATS Controller for Transfer Switching Equipment

ATyS C55/C65





SITE 1940 A

Why do you need Transfer Switching Equipment (TSE)?

Power outages can occur in even the most reliable networks leading to major losses and immense disruption across critical applications, including emergency systems, healthcare devices, server rooms or production lines. To maximise power availability a alternate source is installed, in case of undervoltage, underfrequency or loss of power on the main source the TSE will initiate a transfer to the alternate source. The safe control and switching between one power source and another is essential to guarantee electrical power to critical loads.

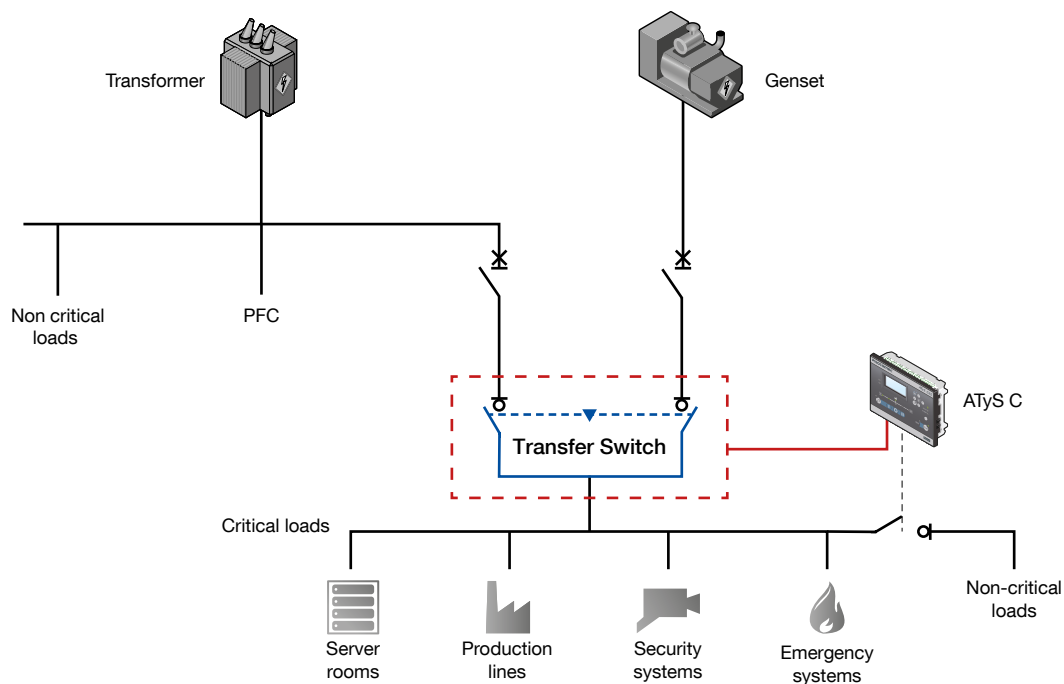

ATyS C 031 A GB

Why choose a Socomec ATS controller ?



Choose the switching expert

Switching has been in Socomec's DNA since 1922. We have engineered and manufactured 5 generations of transfer switches and work continuously on the next generation technology. With a vast experience in the design and development of transfer switching solutions, Socomec is the partner of choice when it comes to ATS controllers for switch type Class PC, circuit breaker type Class CB and contactor type Class CC RTSE.



Think quality first

The C55/65 ATS controllers are engineered and manufactured in France ensuring the highest level of quality, design and functionality. All ATS controllers undergo end-of-line testing and are tested extensively in Tesla lab that is an independent laboratory specialized in the testing of low-voltage equipment and assemblies. Tesla lab also includes facilities to test to the harshest environmental conditions including water resistance, dust ingress, chemical exposure, shock and vibration.



Make your life easier

With ease of use at the heart of the product the C55/C65 will make your life so much easier. We have placed particular importance on the ergonomics of our C55/C65 controllers and engineered them to provide intuitive, straightforward navigation combined with fast and assisted configuration.

Main features

Stay informed
 Event log up to 3000 events
 Field replaceable RTC battery

Simple installation
 Step by step configuration with embedded installation wizard

Your personal controller
 Customisable LED, alarms and maintenance warnings

Visible
 Powerful LED visible up to 30 m

Info in real time
 Pop-up on screen in case of timer, alarm, fault or maintenance operation



Engineered for all Transfer Switching Technology

ATyS C55 and C65 are highly flexible controllers and work with all type of technology: contactor (CC), switch-based (PC), or circuit breaker (CB) class. Especially designed to be used with all type of MCCB and ACB, all parameters can be directly configured from the front face.

Contactor (CC)

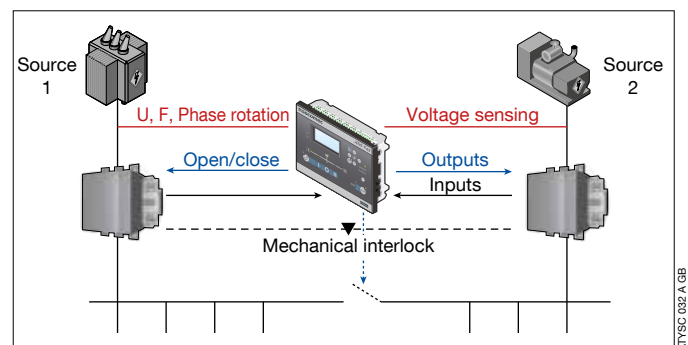

- **Water and UV Resistant**
Up to IP65 and NEMA 3R



- **Easy to use**
Simple and intuitive HMI

- **Always on**
Power supply from both sources, Aux 24 VDC & 30s backup capacitor

- **Adaptable**
I/O extension up to 30 inputs & 18 outputs

- **Safe & simple testing**
Password protected & programmable test functions buttons

Switch-based (PC)

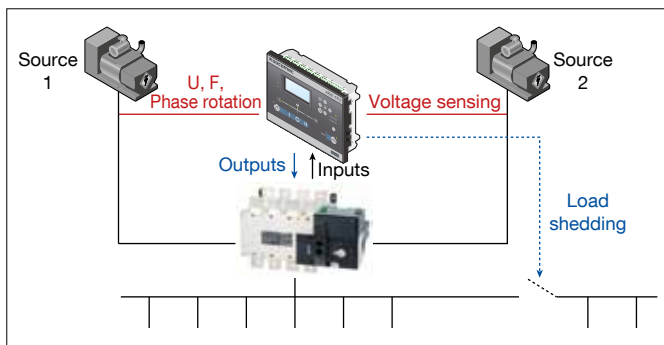

Circuit breaker (CB)

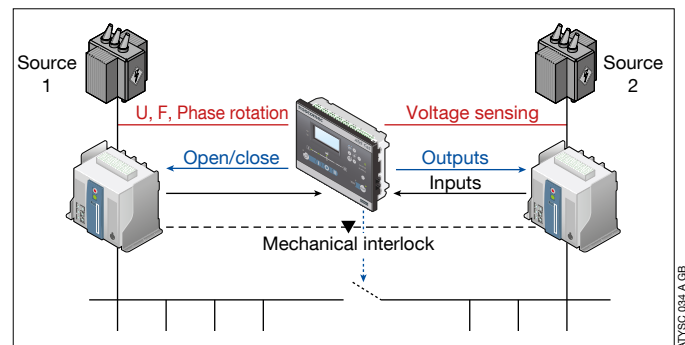

ADD EXTRA

FORCE

ABOVE STANDARD

Choose the **safe and reliable solution** for your transfer switch controller by selecting products tested to your local standards. The ATyS C55 and C65 have been designed to meet and exceed **the most demanding product standard safety requirements** as a minimum the ATyS C55/C65 ATS controllers are compliant with IEC 61010-2-201, IEC 60947-6-1 when type tested with a certified RTSE. They also comply with GB/T 14048.11 for China including Annex C which is specific for stand-alone ATS controllers. The ATyS C55/65 have also been designed to meet the requirements of installation standards IEC 60364, NFPA 70 and NFPA 110 whilst a specific version C66 will be available and certified to UR 1008 and UL 61010 requirements.



To guarantee the safe transfer in the **harshest conditions**, the ATyS C55 and C65 ATS controllers are tested to the **highest quality** and **endurance standards**.



Suitable for indoor and outdoor applications with temperatures ranging from -30 °C to +70 °C, our controllers are water resistant up to a degree of IP 65 and **UV protected** according to NEMA 3R12.



The ATS controller is also suitable for installation in the main distribution board with an overvoltage category of OVC III.

SPEED

TO YOUR TRANSFER SWITCHING EQUIPMENT

FAST CONFIGURATION

Configuration is faster than ever with the **smart configuration wizard**; this intelligent wizard assistant will prompt all the right questions to ensure that the product is up and running as quickly as possible. Based on a **highly ergonomic design**, the C55/C65 controller is **the most intuitive ATS controller on the market**.

USER FRIENDLY

The ATS controller includes a **high resolution 350x160 pixel screen** that provides a clear and sharp display of key information. The dashboards enable the user to **access all the main data** at the push of a button. The HMI is clearly defined with dedicated push-buttons, indication LED's and pop-up messages on the LCD screen to ensure that all functionalities are **made easy for all users**. With nine languages available for all menus, alarms and timers, including EN, FR, ES, DE, CN, IT, PT, TR, PL.

Dashboards: a simple and clear way to visualise all the main data with one single push-button

- **Summary**
Full synoptic of your installation
- **Status**
Status and synchronisation of sources
- **Metering**
Current and voltage metering values
- **Power & Energie**
Power & energie values (P, Q, S) in graph or number mode
- **Timers**
Ongoing timers & possibility to bypass
- **Alarms**
Ongoing system or user alarms
- **Input/outputs**
Status & function of each I/O
- **Maintenance**
Time and operations before next maintenance (user programmable)

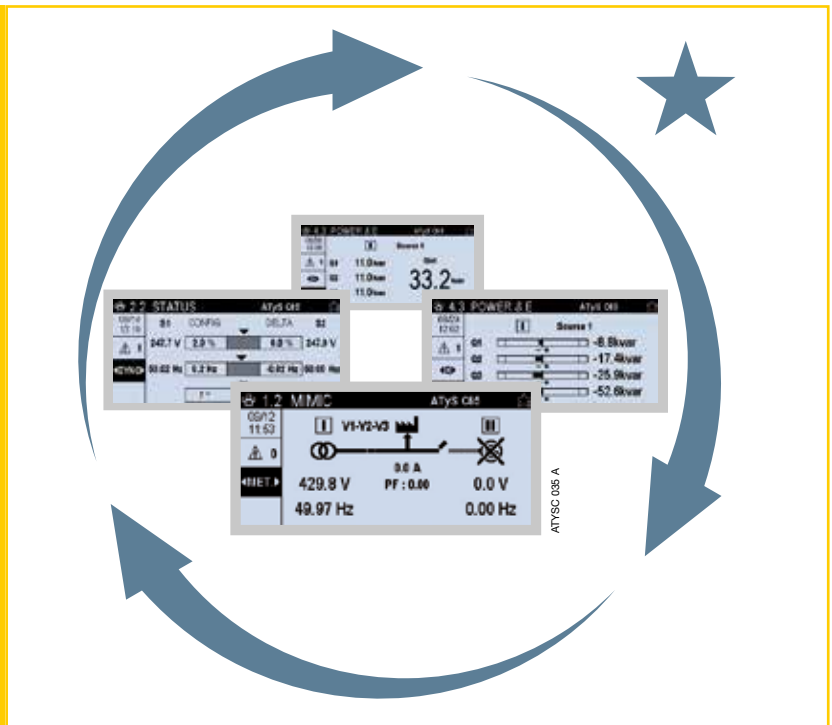

ADD EXTRA

POWER

TO YOUR TRANSFER SWITCHING EQUIPMENT

TRIPLE CONSTANT POWER

Never in the dark and always a step ahead with the C65 controller.

Even if all power sources are lost the ATS controller will remain powered with the LCL, display, LED'S and communication functional; this insure clear comprehension of the status of the installation whatever the situation.

The user will always know what is going on within the installation.

30 seconds
back-up



24 VDC

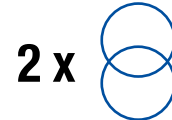

- 30 s built-in Energy backup maintains communications going and keeps the controller running through a total blackout until the power is restored from a backup generator.
- 24 VDC optional power supply input.
- Supplied from sensing on both source 1 and source 2.

POWER MONITORING

In addition to information about source availability and switch position, you can also monitor the load directly with the ATS controller and 1/5A CT's. All the source and load management information is contained within **one central unique device - including current and power metering and energy consumption for each source**. Besides classic metering, monitoring allows for specific functions such as smart load shedding, graphs, measurement alarms...

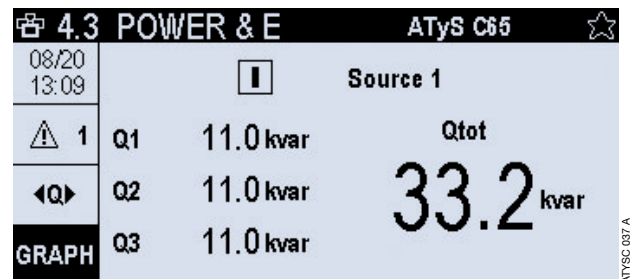

Selection guide



Reference	1600 0055	1600 0065	1600 0066
Name	ATyS C55	ATyS C65	ATyS C66
Application	CC (Contactor)/PC (Switch-based)/CB (Circuit Breaker)		
Types of source management	Main/Main - Main/Genset - Genset/Genset		
Power			
AC Voltage range - Network voltage	80-576 V	80-576 V	80-576 V
Voltage sensing Source 1 & Source 2	•	•	•
DC power supply (optional)	12-24 VDC	12-24 VDC	12-24 VDC
Self-powered from voltage sensing	•	•	•
30 seconds energy back-up during blackout	•	•	•
Supplied from USB for configuration	•	•	•
Standards			
IEC-61010-2-210	•	•	•
GB/T 14048.11 Annex C	•	•	•
UL1008			•
cULus 61010			•
Network types			
1ph+N (single phase) networks	•	•	•
3ph+N networks	•	•	•
3ph and 2ph networks	•	•	•
Mixed 3ph+N (source 1)/1ph+N (source 2) networks	•	•	•
Installation / Commissioning			
Dimensions mm (H x W x L) / door cutout (H x W)		180 x 240 x 64	
Back plate mounting	•	•	•
Door mounting mm (H x W)		160 x 220	
Configuration wizard & autodetect	•	•	•
Environment			
IP degree	IP40 (IP65 with gasket)	IP65	IP65
HMI			
LCD screen	•	•	•
D-70 remote annunciator (Digiware)	•	•	•
Web server visualisation with D-70 or M-70 gateways (Digiware)	•	•	•
I/O			
N° Inputs	6 fully programmable	6 fully programmable	6 fully programmable
N° Outputs - Non latching 8 A/277 VAC		4 fully programmable	
N° Outputs - Latching with energy backup 8 A/277 VAC		2 fully programmable	
Elevator output signal		•	•
Load shedding output signal		•	•
Expansion modules		Up to 6/total 30in/18out	Up to 6/total 30in/18out
Sensing & Monitoring			
V & U sensing all phases	•	•	•
V, U, PF visualisation per phase		•	•
Source sync. Monitoring - in phase transfer		•	•
Functions			
Current, Power, Energy monitoring		•	•
Event log time stamped (n° of events)	300	3000	3000
Event search by date		•	•
Logic, system, maintenance alarms	•	•	•
RTC with field replaceable battery	•	•	•
Measurement, combination alarms		•	•
Test modes (manual & remote)		On load / Off load	
Control inhibition	•	•	•
Engine Exerciser programs	1	4	4
In-phase transfer for fast transfer switches (I-II)		•	•
Return to 0		•	•
Communications			
RS485 (Modbus RTU)	•	•	•
Comm through M-70 gateway		Ethernet / SNMP / BACnet	
USB for update & power supply	•	•	•

Name	Reference	Description	Compatible with
DIRIS Digiware IO-10	4829 0140	4 inputs + 2 outputs extension module	C65 / C66
DIRIS Digiware M-70	4829 0222	Communications gateway	C55 / C65 / C66
DIRIS Digiware D-70	4829 0202	Communications gateway + annunciator	C55 / C65 / C66
Mounting accessories	1600 0001	Gasket of IP65 (outdoors) on C55	Already included for C65 / C66

The configuration software made easy

Easy Config System



Direct or remote configuration

Configure with USB and remotely using the imbedded RS485 or though Socomec M-70 & D-70 gateways.



Visualise your configuration

Program a full system and visualise the system in real time.



Save & import

Save and import anytime by creating configuration files with or without products connected.

Download Easy Config System (ECS) for free at www.socomec.com/easy-config

WEBVIEW

Visualise all your DIRIS Digiware ready products on one interface.



Embedded EMS

No installation required: WEBVIEW analysis and monitoring software is integrated in DIRIS Digiware M-70 and D-70.



Photoview functionality

Display of electrical parameters from multiple devices on a customised background picture such as an electrical diagram or a site drawing.



Secure

Cybersecurity features implemented to secure the exchange of data and navigation on the webserver.

Monitoring and alarms

- Instant controller status position, I/O, etc...
- State and settings of all timers.
- Summary of alarms on all Digiware connected products.
- Alarms sent by email.

Viewing

- Illustrated view of your installation with real time values.
- User customizable overview.
- High storage capacity of log history.

Analysis

- Analysis of energy consumption.
- View per location, location and utility type.
- Secure and automatic export of data in CVS format.

A full Digiware system

The ATyS C65 controller is fully compatible with our power metering and monitoring system DIRIS Digiware. No more need to add extra voltage modules, use your controller as a voltage sensing module (equivalent to DIRIS Digiware U-10) allowing you to have the voltage of both sources on the same system with just one product.

All your information are centralized through a gateway DIRIS Digiware M-70 (din-rail) or D-70 (remote annunciator display) with integrated webserver and Modbus TCP, SNMP or BACnet protocols to communicate with your facility management software.

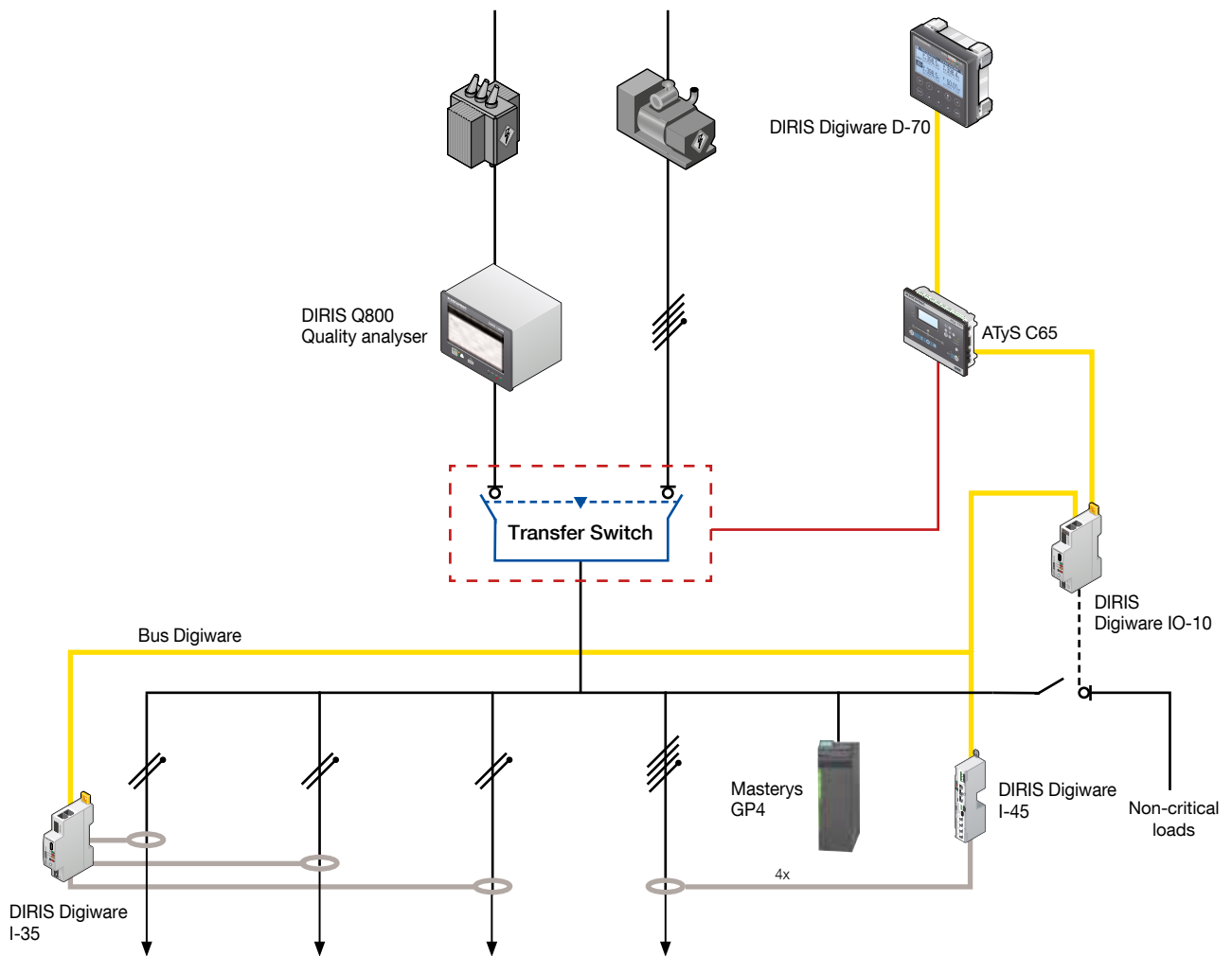

What is DIRIS Digiware ?



DIRIS Digiware is a power metering and monitoring system for AC and DC electrical installations. This technological system revolutionises the world of electrical measurement, bringing a high degree of flexibility to installations and making connection and configuration easy. These innovations, together with unrivalled performance in terms of accuracy and functionality, make DIRIS Digiware the most effective solution for metering consumption, and for measuring and monitoring the quality of electrical energy in industrial and commercial applications.

Socomec: our innovations supporting your energy performance

1 independent manufacturer

3,600 employees
worldwide

10 % of sales revenue
dedicated to R&D

400 experts
dedicated to service provision

Your power management expert



POWER
SWITCHING



POWER
MONITORING



POWER
CONVERSION



ENERGY
STORAGE



EXPERT
SERVICES

The specialist for critical applications

- Control, command of LV facilities
- Safety of persons and assets
- Measurement of electrical parameters
- Energy management
- Energy quality
- Energy availability
- Energy storage
- Prevention and repairs
- Measurement and analysis
- Optimisation
- Consultancy, commissioning and training

A worldwide presence

12 production sites

- France (x3)
- Italy (x2)
- Tunisia
- India
- China (x2)
- USA (x3)

28 subsidiaries and commercial locations

- Algeria • Australia • Belgium • China • Canada
- Dubai (United Arab Emirates) • France • Germany
- India • Indonesia • Italy • Ivory Coast • Netherlands
- Poland • Portugal • Romania • Serbia • Singapore
- Slovenia • South Africa • Spain • Switzerland
- Thailand • Tunisia • Turkey • UK • USA

80 countries

where our brand is distributed

HEAD OFFICE

SOCOMECC GROUP

SAS SOCOMECC capital 10 607 040 €
R.C.S. Strasbourg B 548 500 149
B.P. 60010 - 1, rue de Westhouse
F-67235 Benfeld Cedex
Tel. +33 3 88 57 41 41 - Fax +33 3 88 57 78 78
info.scp.isd@socomecc.com

YOUR DISTRIBUTOR / PARTNER

www.socomecc.com



100 years
OF SHARED ENERGY
1922 — 2022

socomecc
Innovative Power Solutions